

CORTE 2-2
Escala 1:50

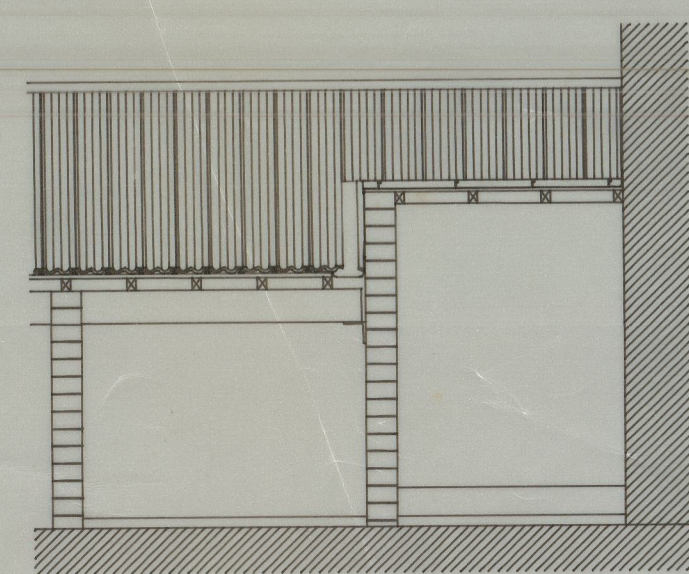

CORTE 3-3
Escala 1:50

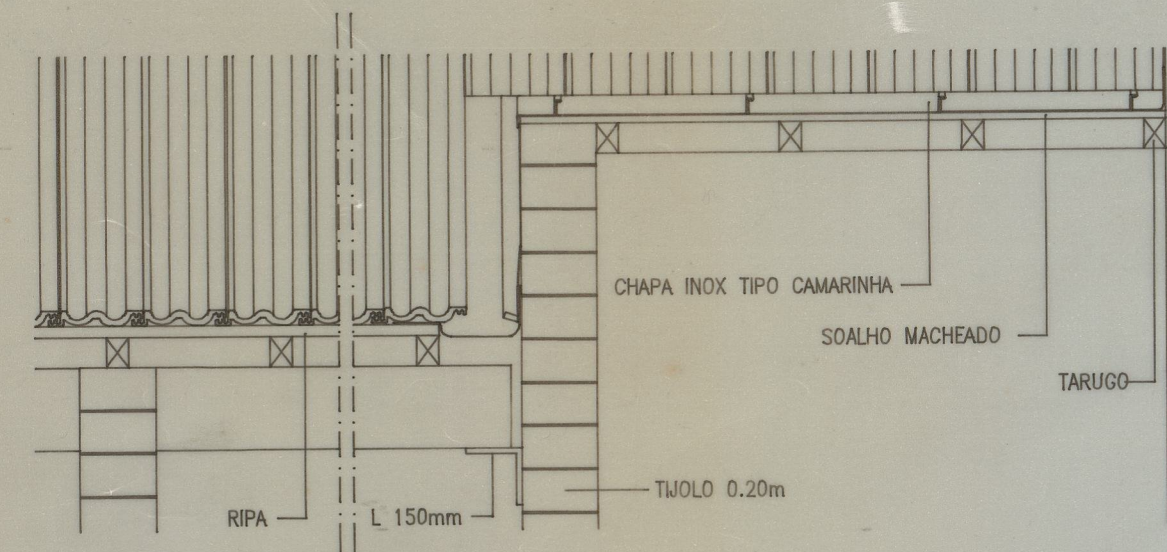

CORTE 2-2
Escala 1:20

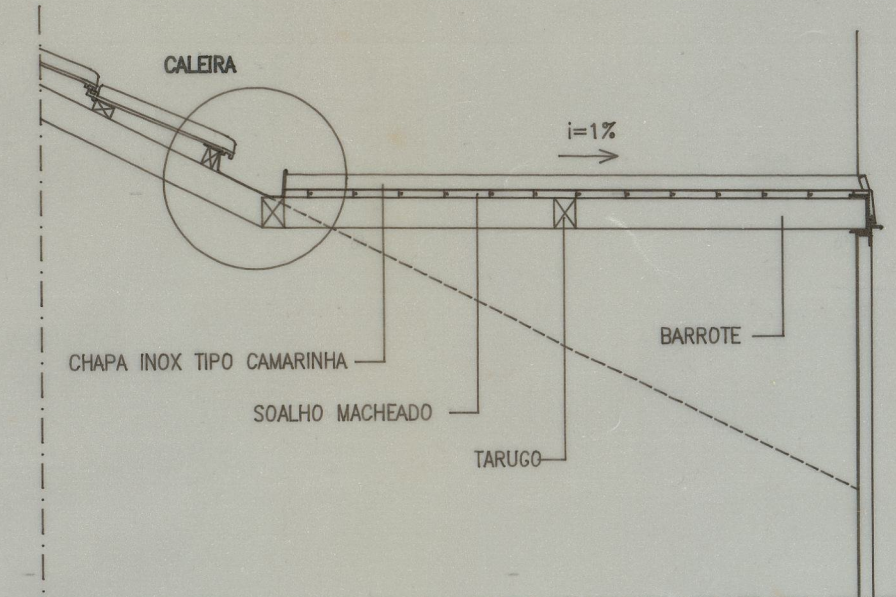

CORTE 3-3
Escala 1:20

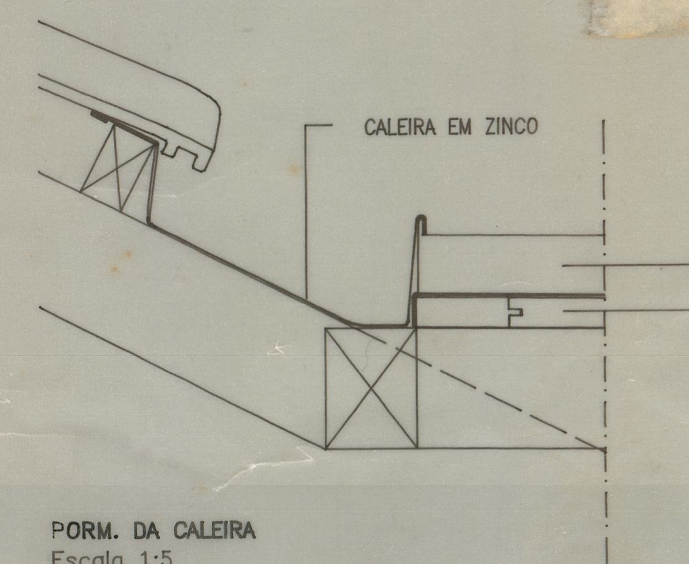

FORM. DA CALERA
Escala 1:5

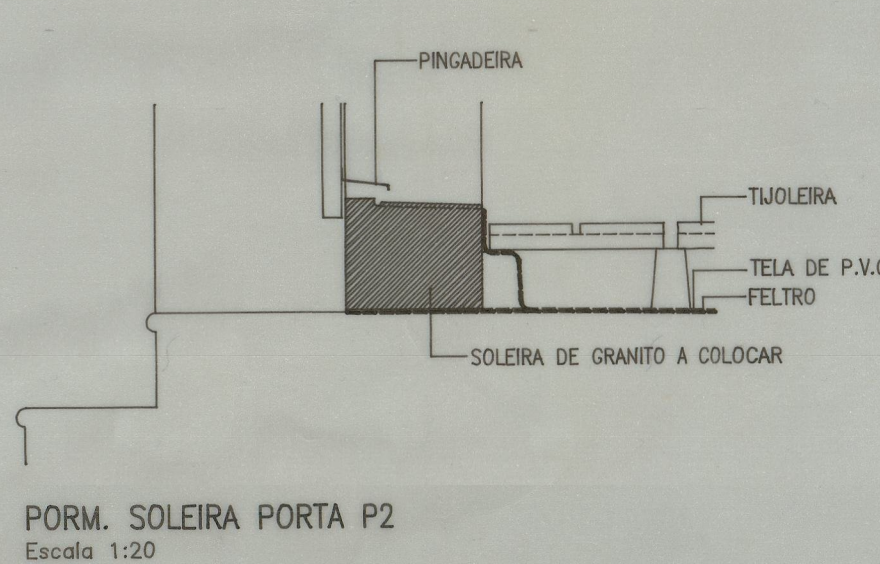

FORM. SOLEIRA PORTA P2
Escala 1:20

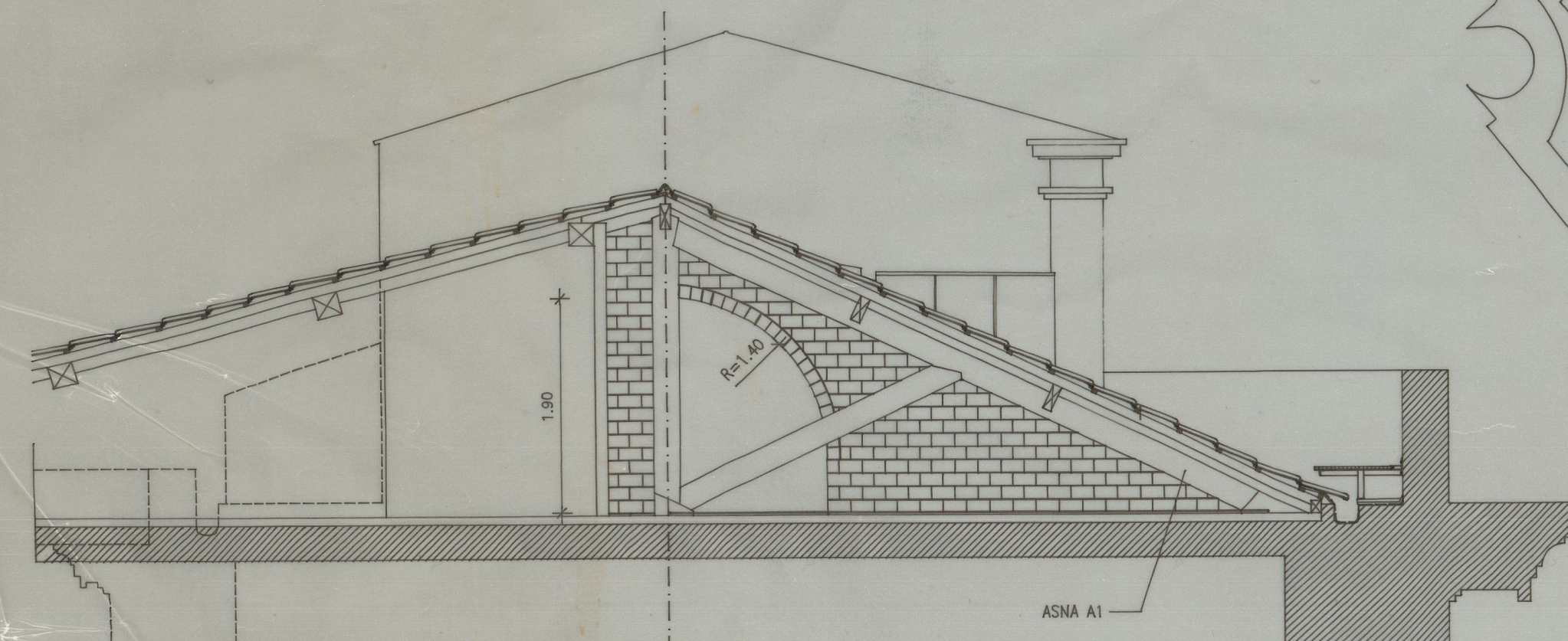

CORTE 1-1
Escala 1:50

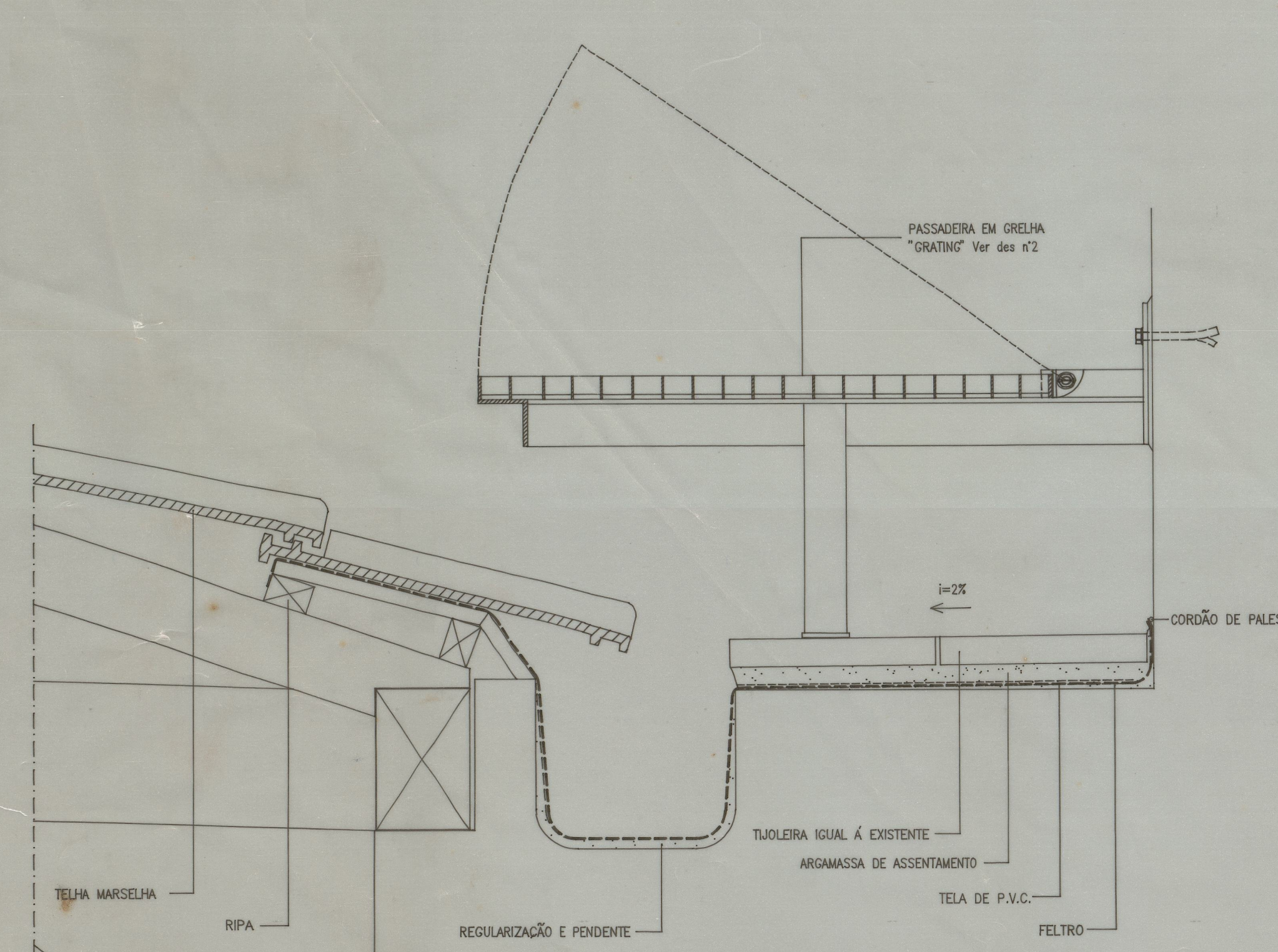
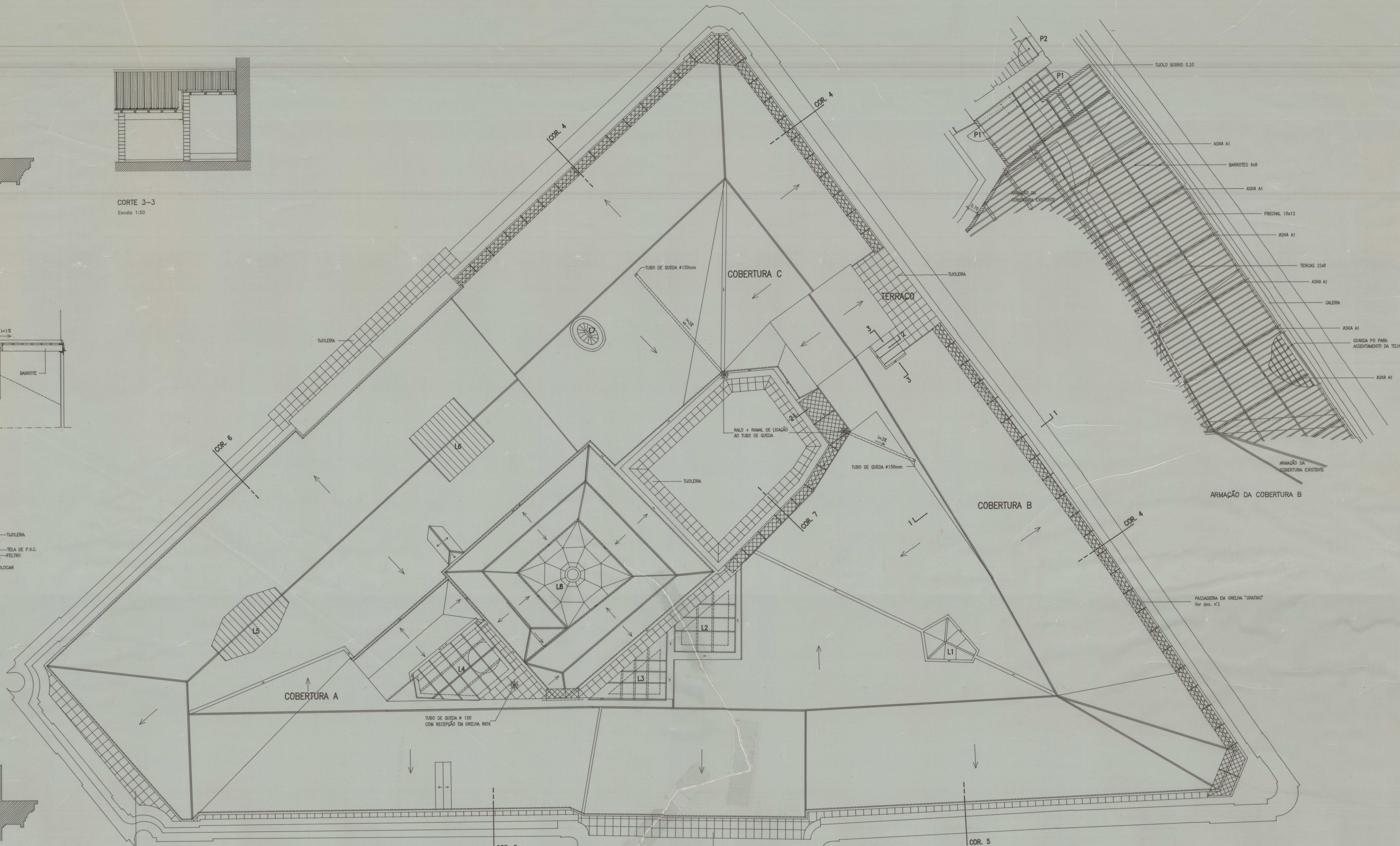

CORTE 4
Escala 1:5

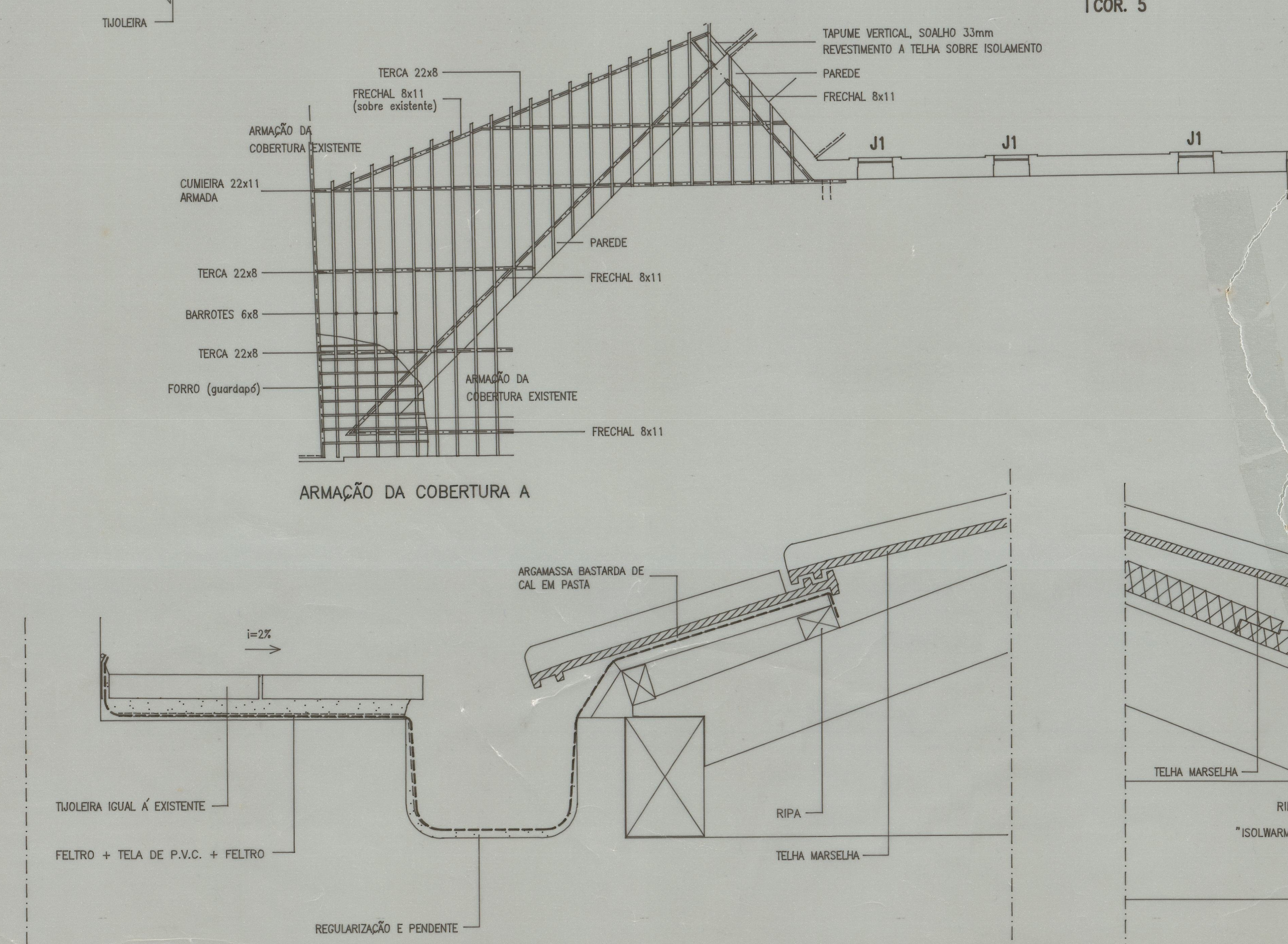

CORTE 5
Escala 1:5

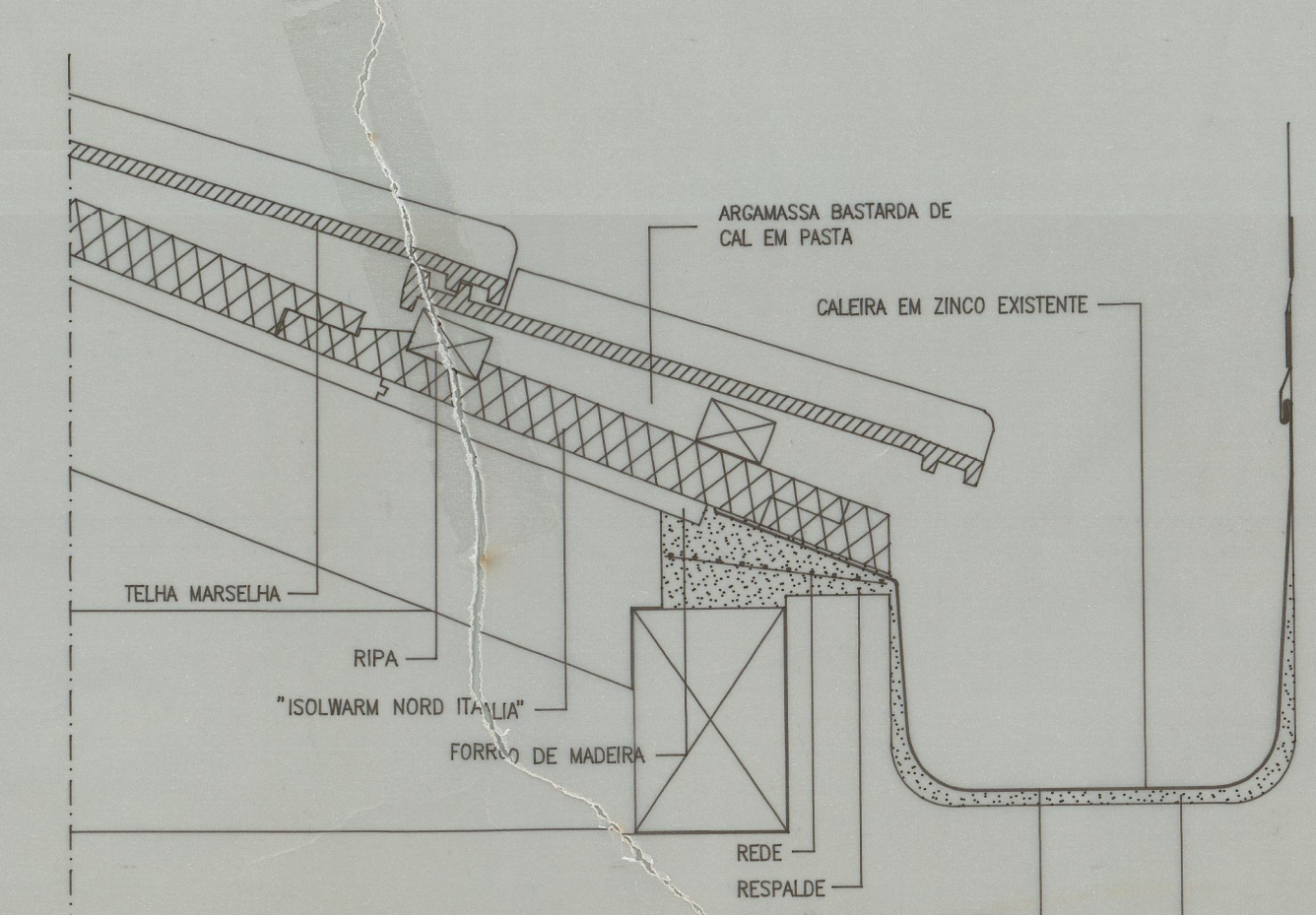

CORTE 6
Escala 1:5

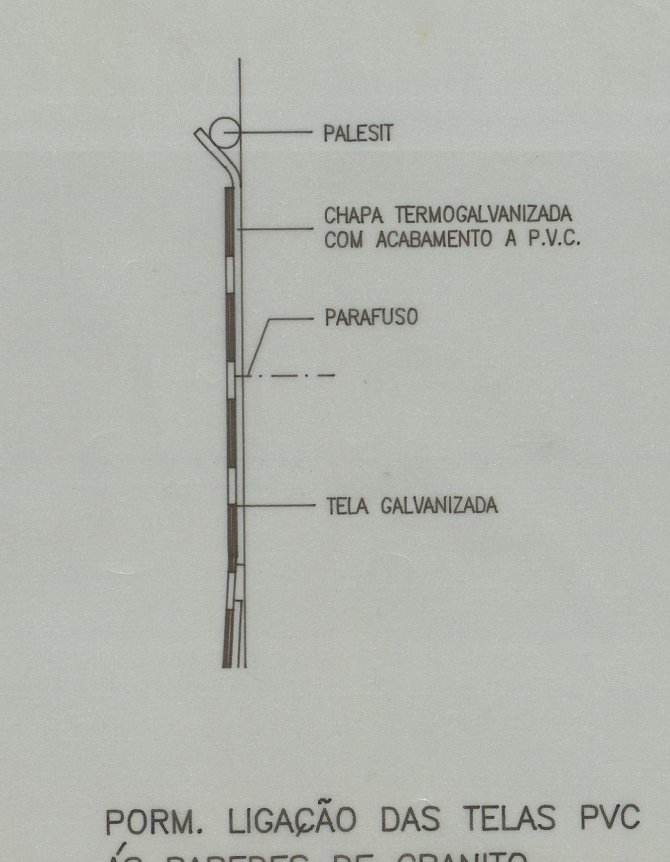

FORM. LIGAÇÃO DAS TELAS PVC ÀS PAREDES DE GRANITO
Escala 1:1

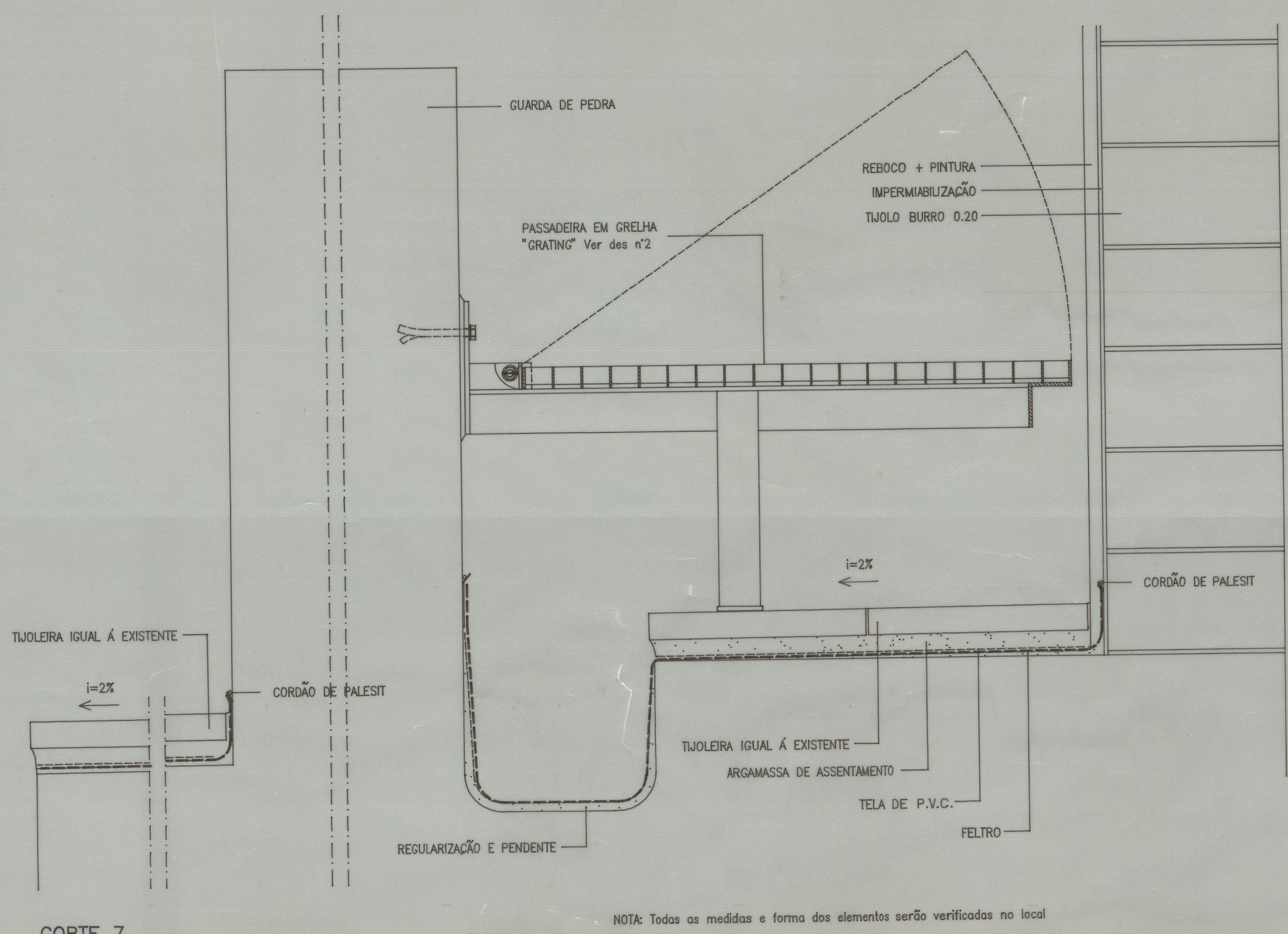

CORTE 7
Escala 1:5

NOTA: Todas as medidas e formas dos elementos serão verificadas no local.

PROJ. ARQUITETÓNICO	col. nº 1010	de 1980	1/100 x 1/5	01
PROJ. ENGENHEIRO	col. nº 1010	de 1980	1/100 x 1/5	01

11351
2468