

Chapas metálicas do Ligação 2 (Escala 1:2)

Chapa 'A' (x12)

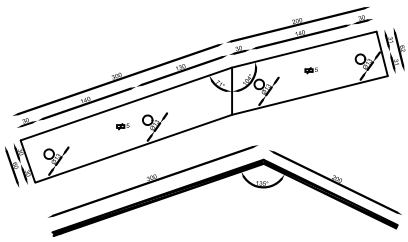

Chapa 'C' (x12)

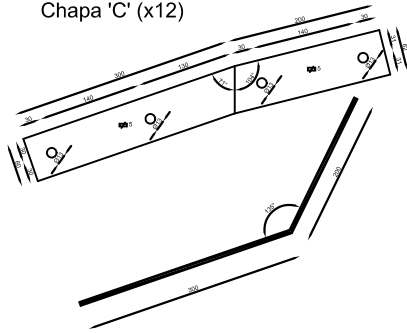

Chapa 'B' (12)

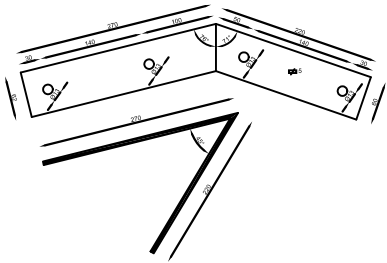

Chapa 'D' (x12)

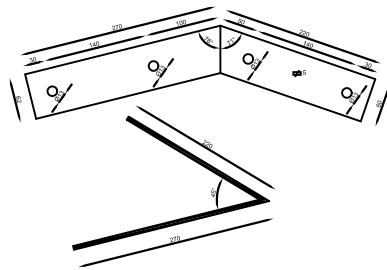

Chapa metálica do Ligação 1 (Escala 1:5)

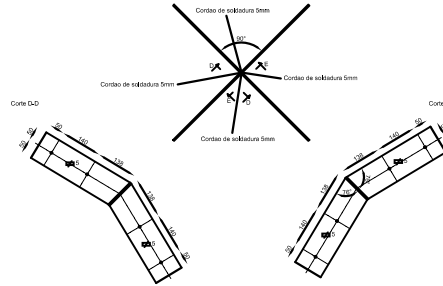

Chapa metálica do Ligação 3 (Escala 1:5)

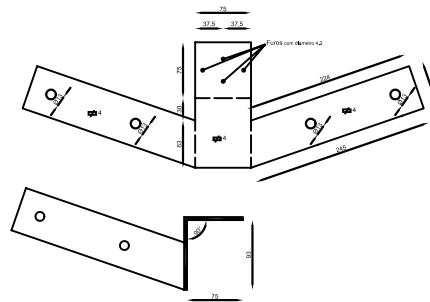

Chapa metálica do Ligação 4 (Escala 1:2)

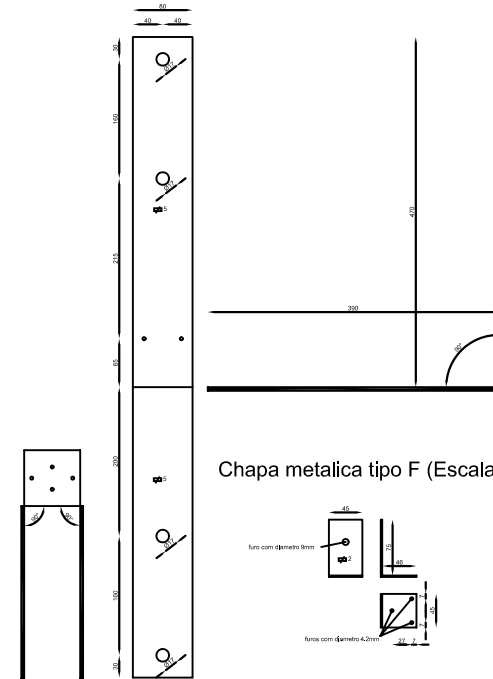

Chapa metálica E (Escala 1:2)

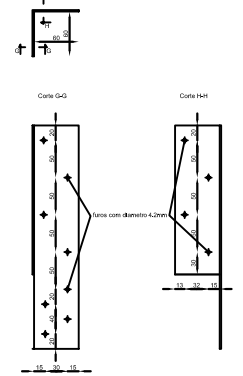

Chapa metálica tipo F (Escala 1:2)

