

M1 - Porm. 3

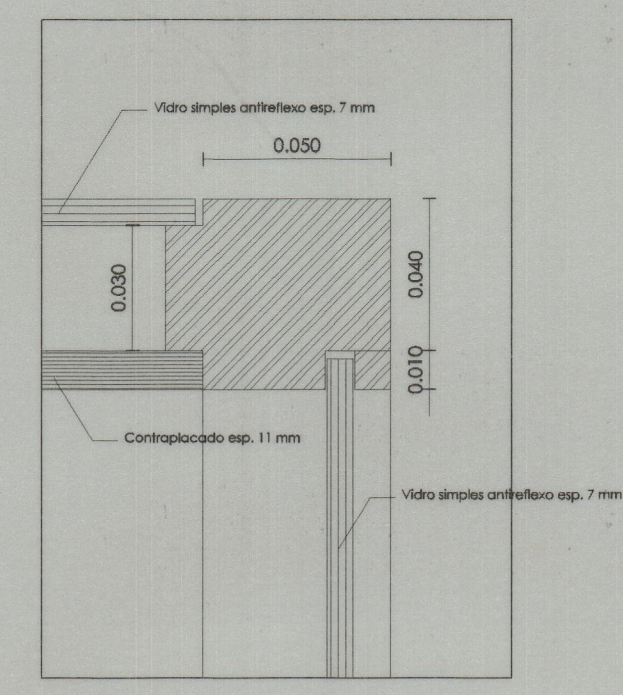

M1 - Porm. 4

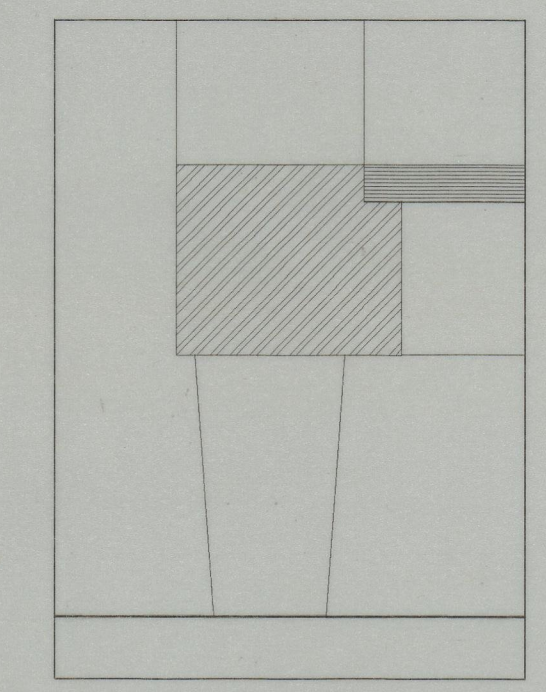

M1 - Porm. 5

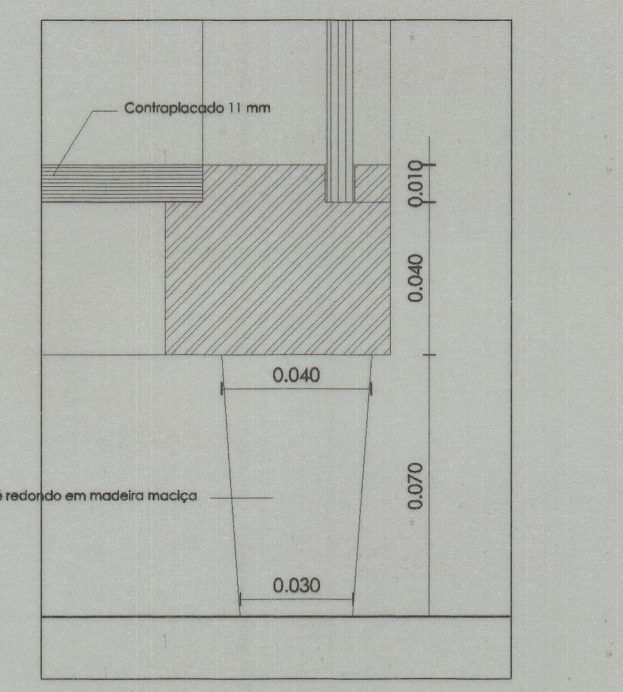

M1 - Porm. 6

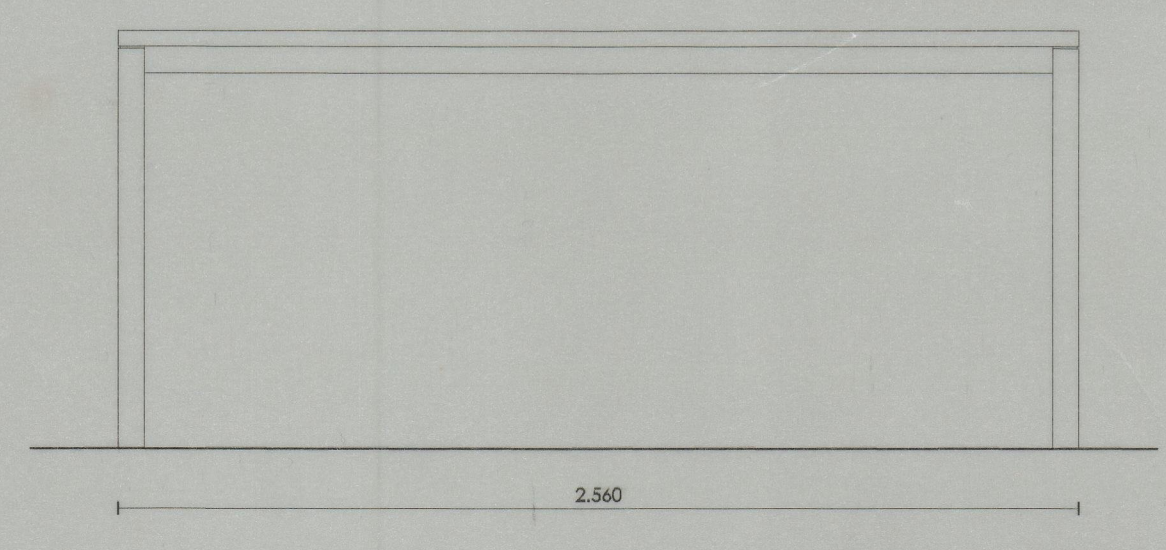

M4

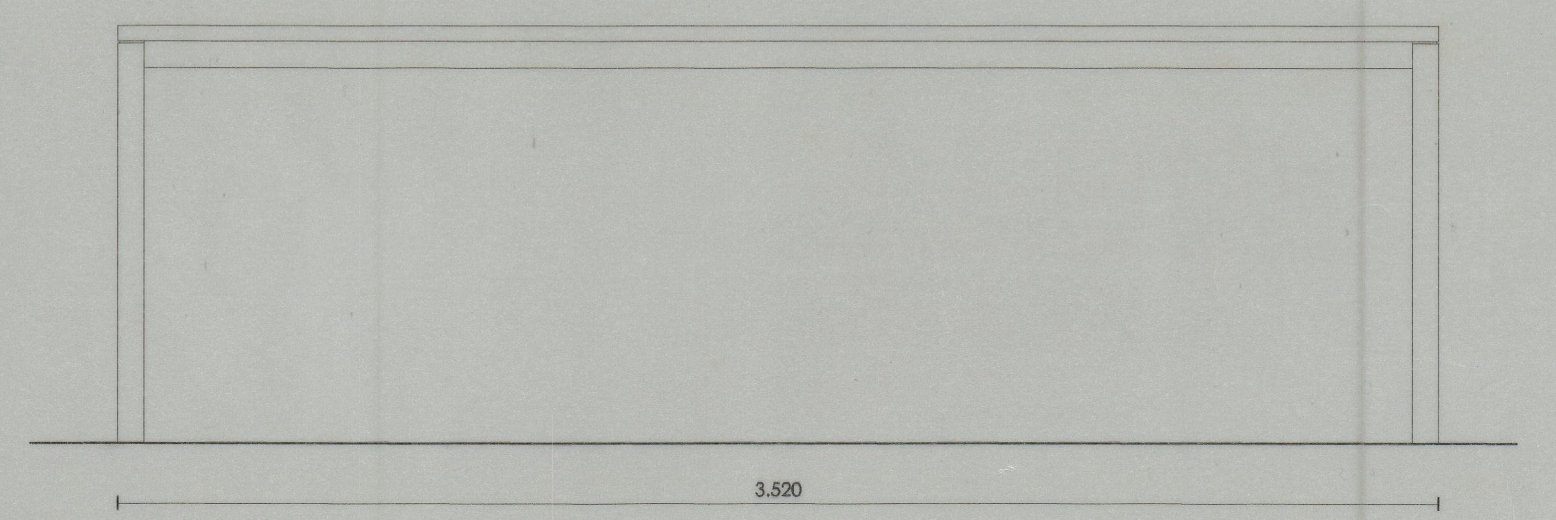

M6

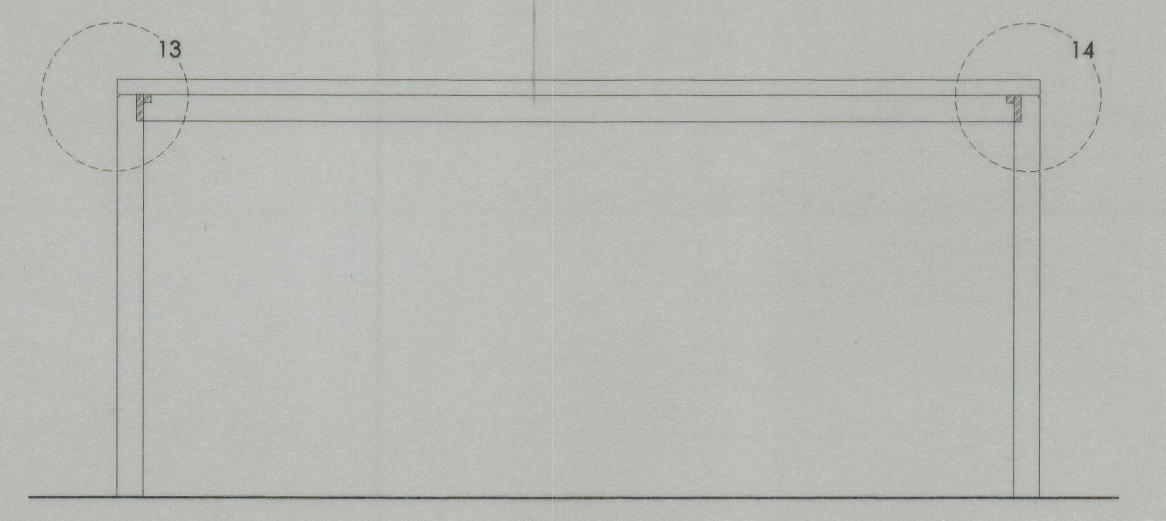

M3

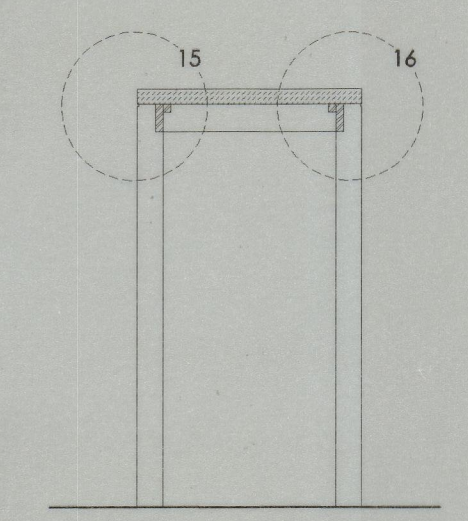

M15

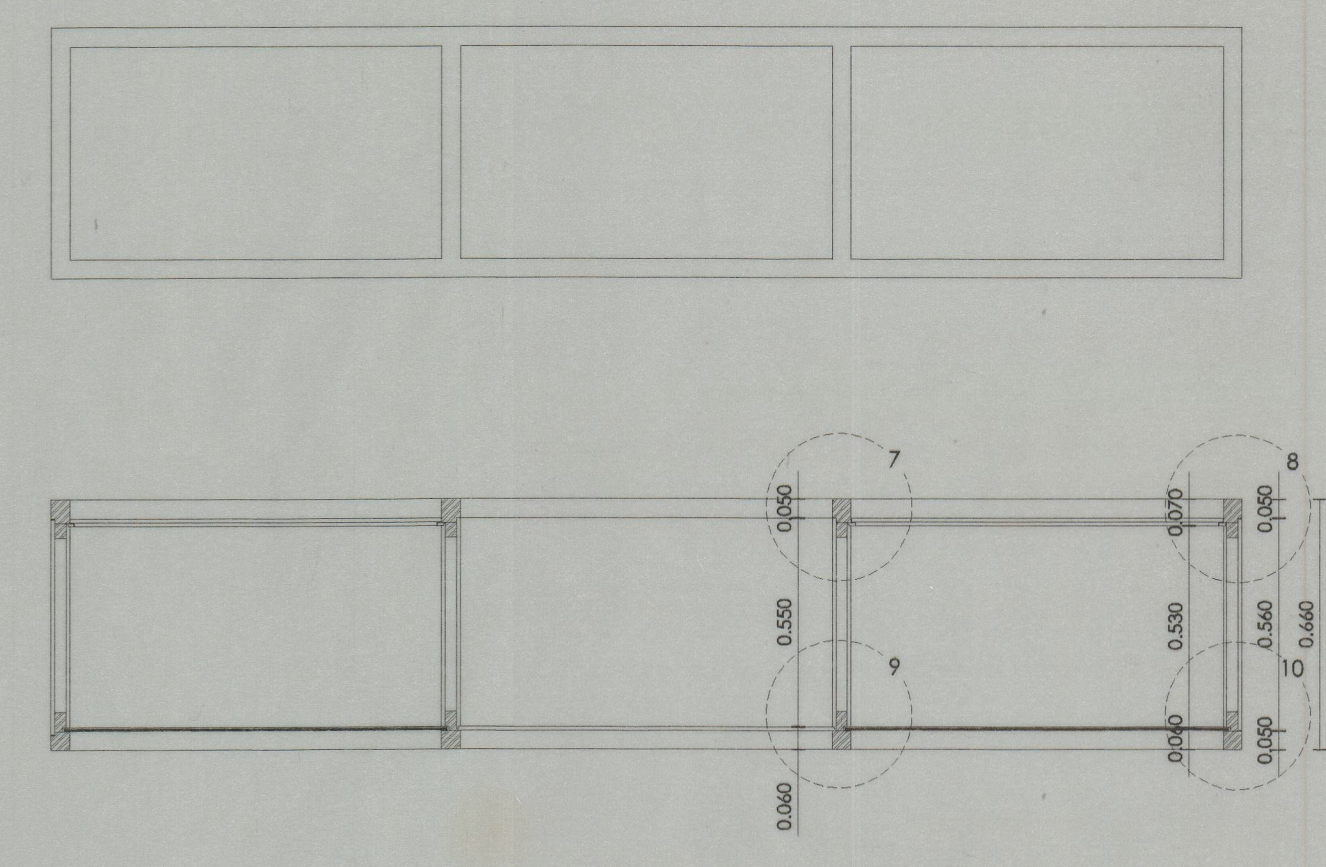
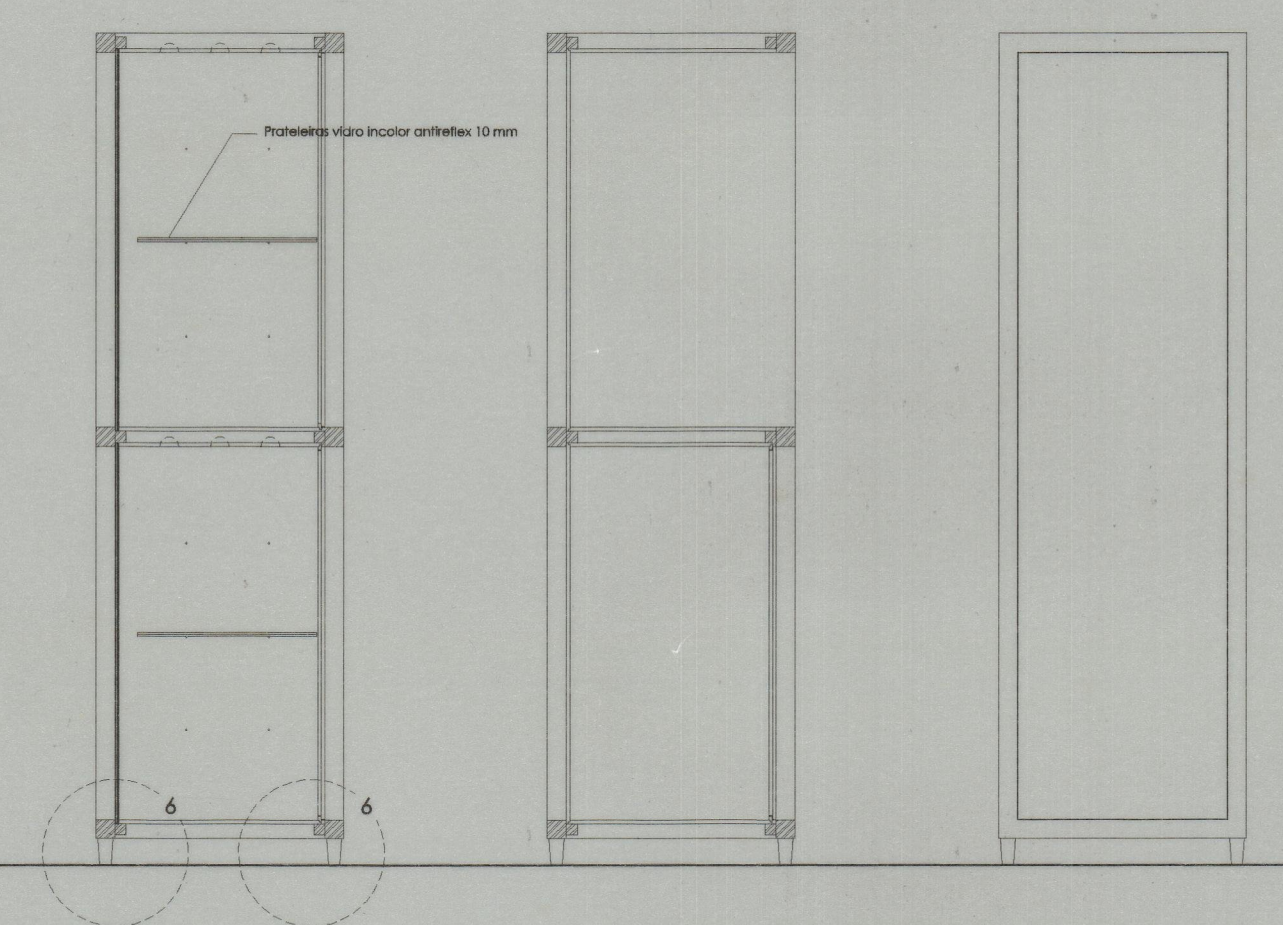
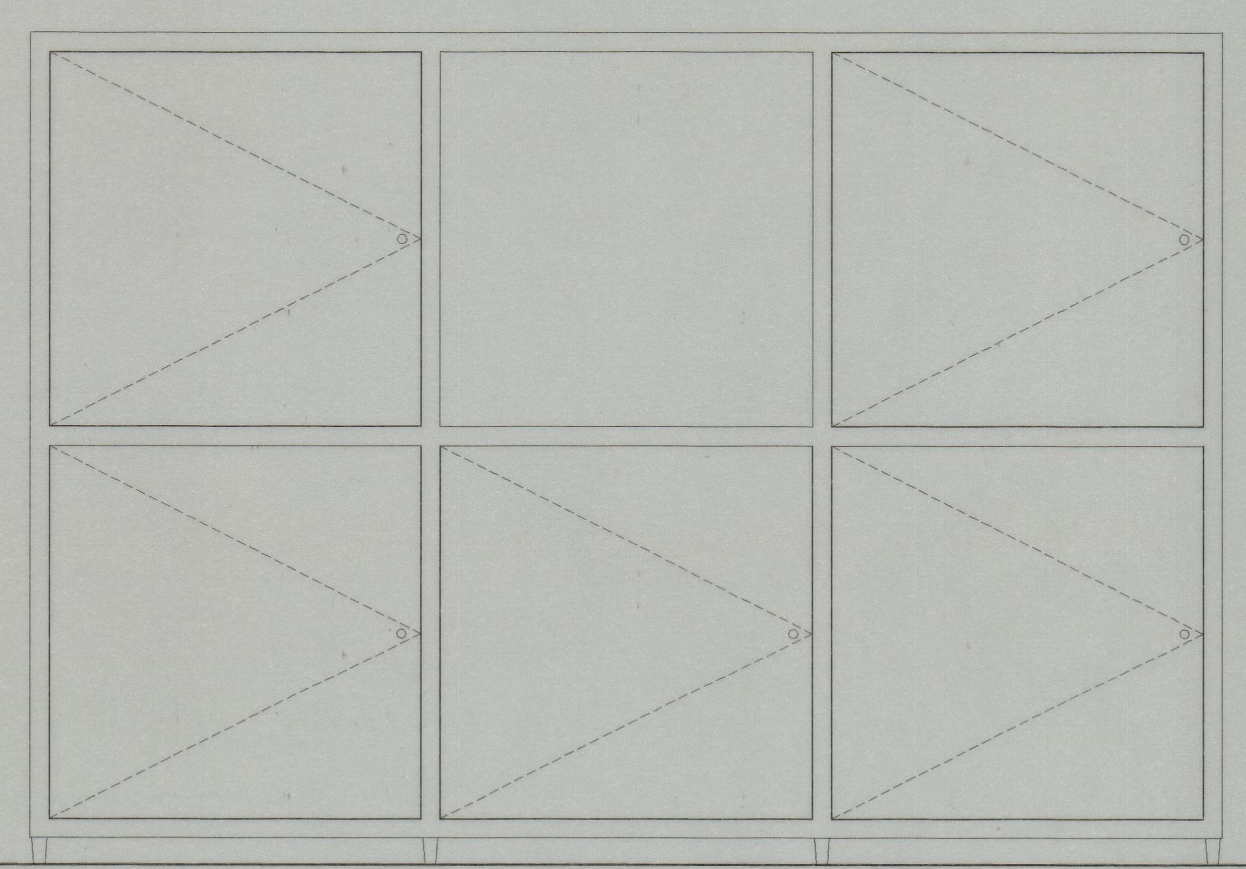
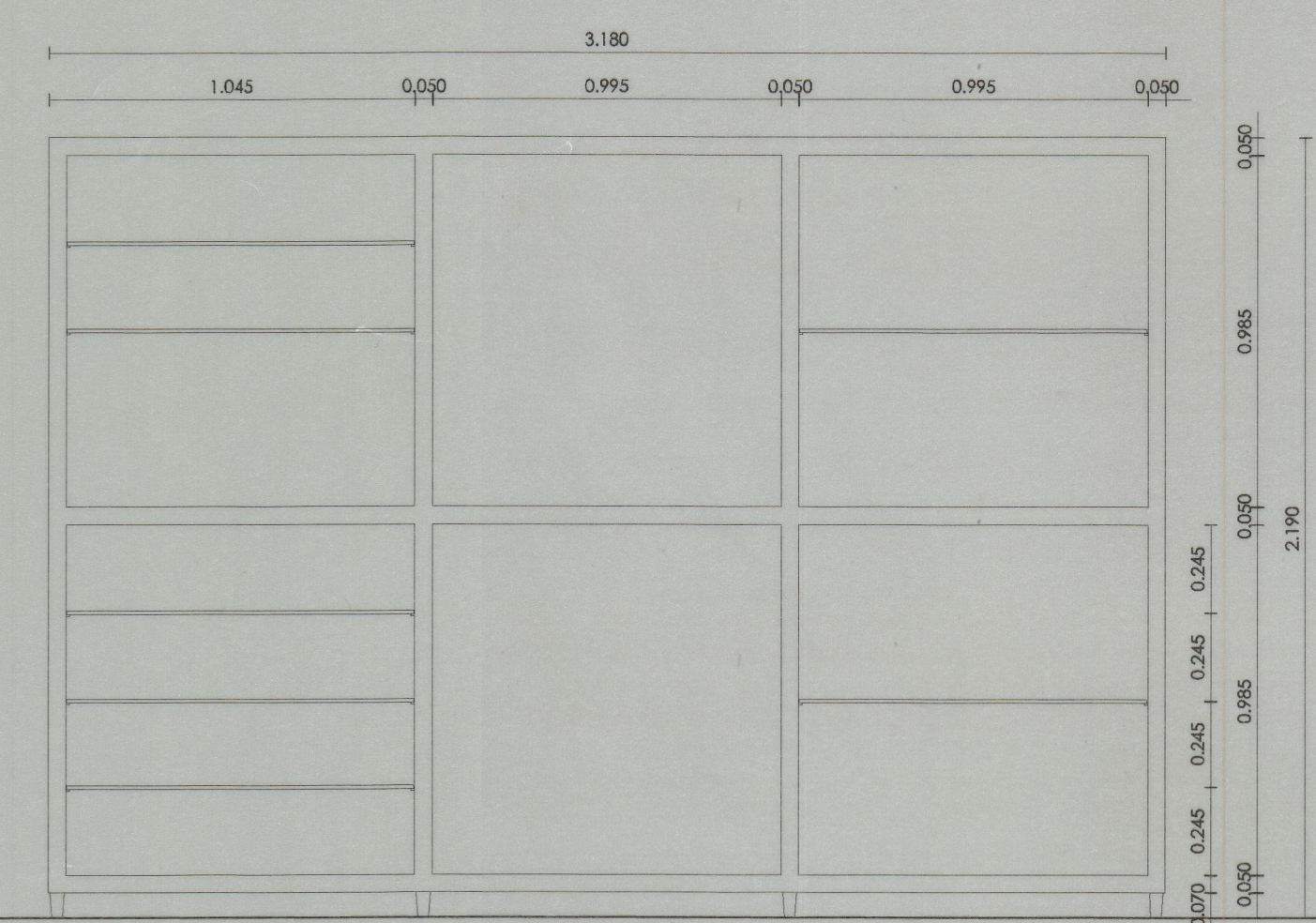
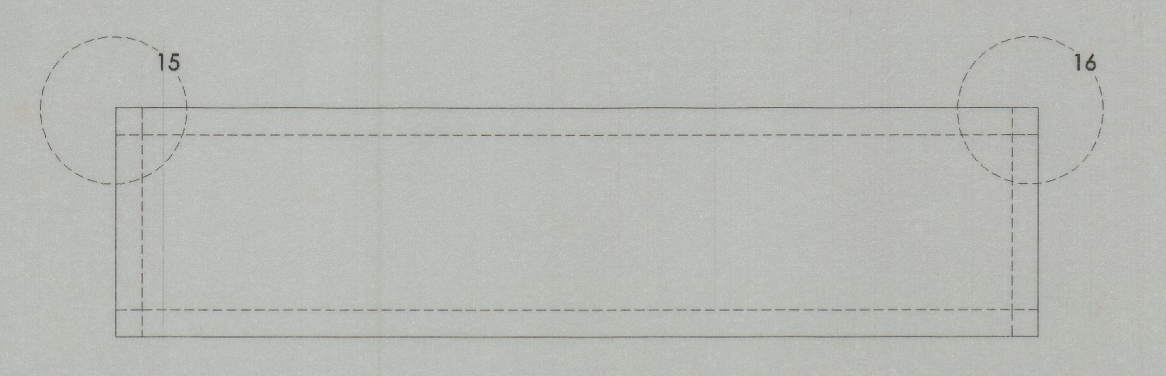
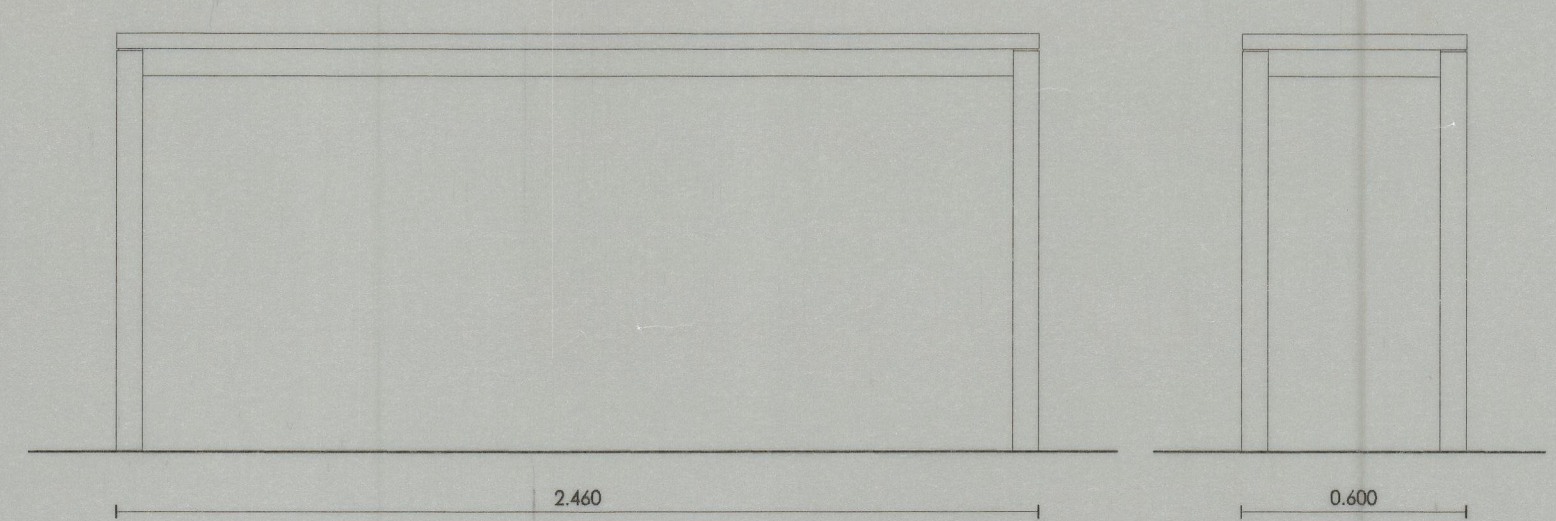

M3

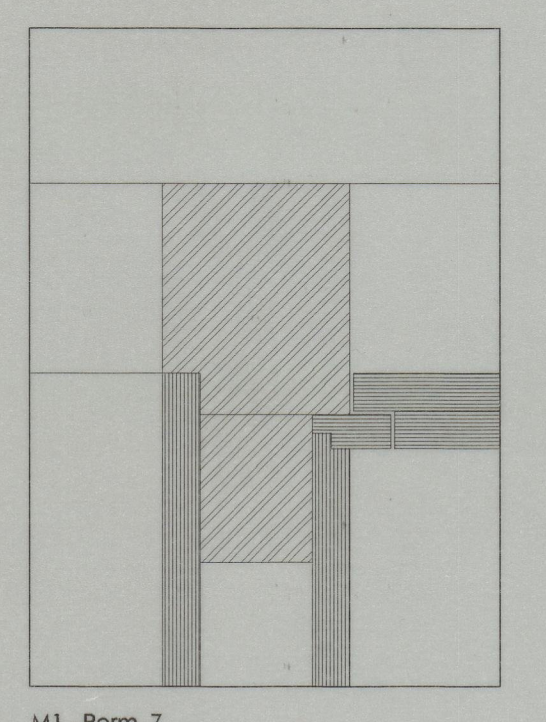

M1 - Porm. 7

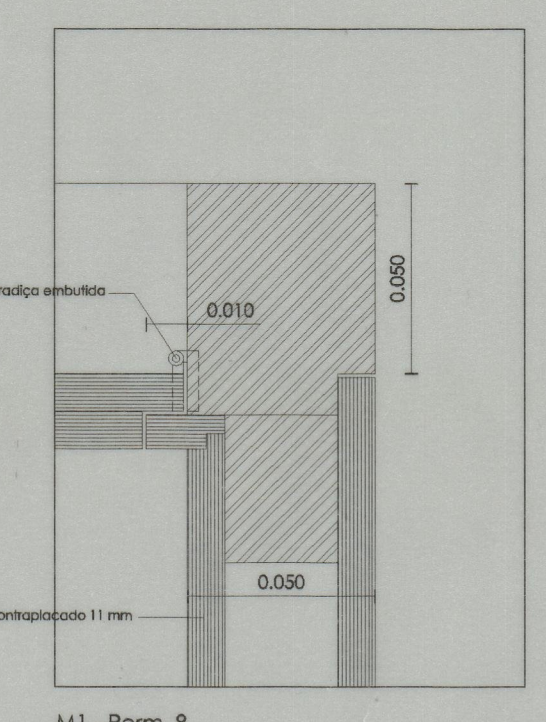

M1 - Porm. 8

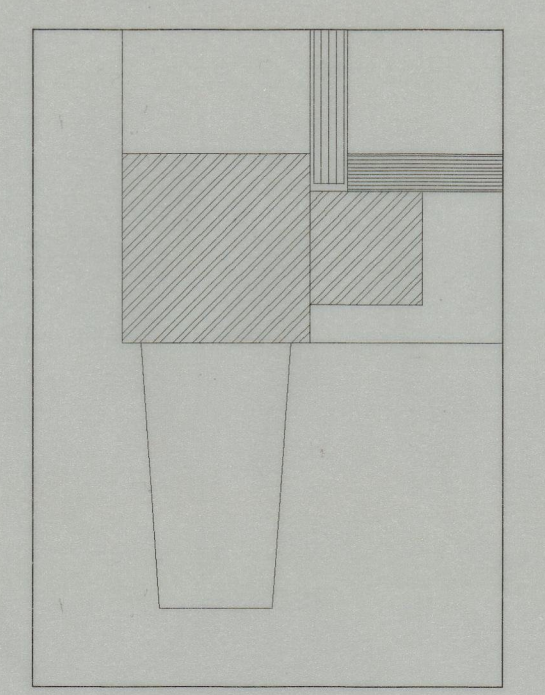

M2 - Porm. 11/vertical

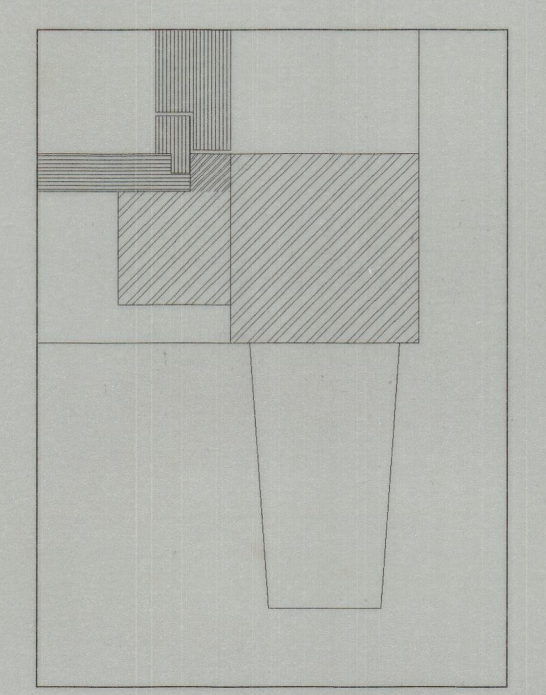

M2 - Porm. 12/vertical

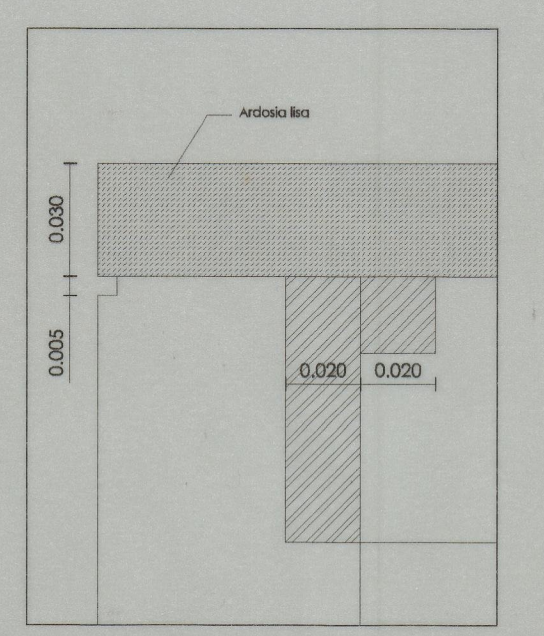

M3 - Porm. 13/vertical

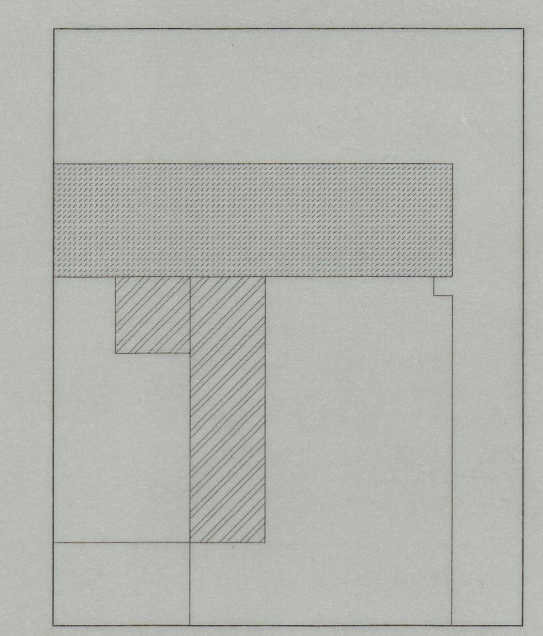

M2 - Porm. 13a/vertical

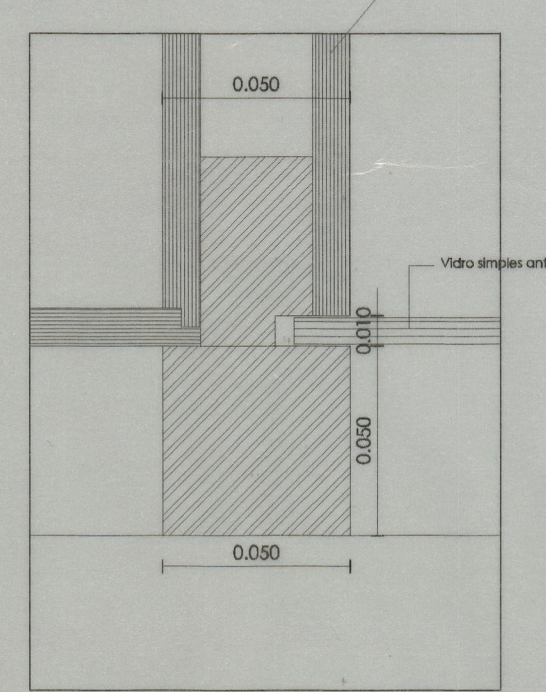

M1 - Porm. 9

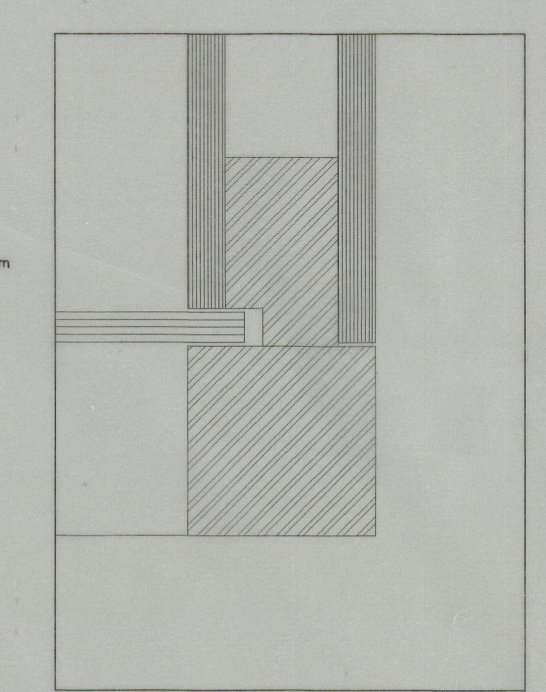

M1 - Porm. 10

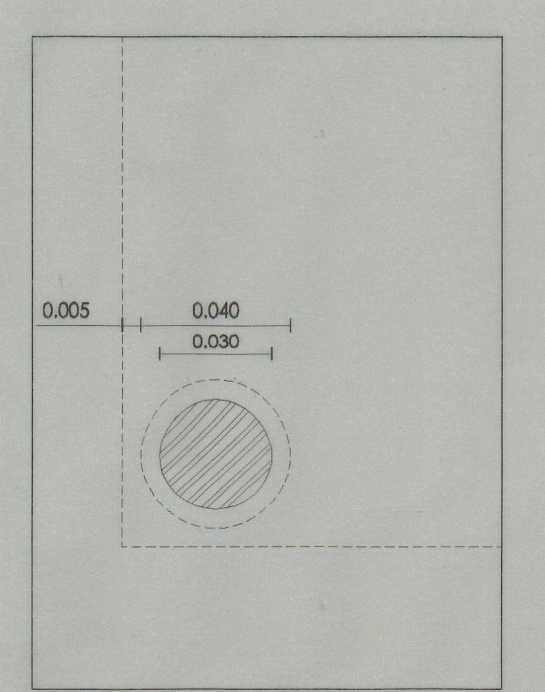

M2 - Porm. 11/horizontal

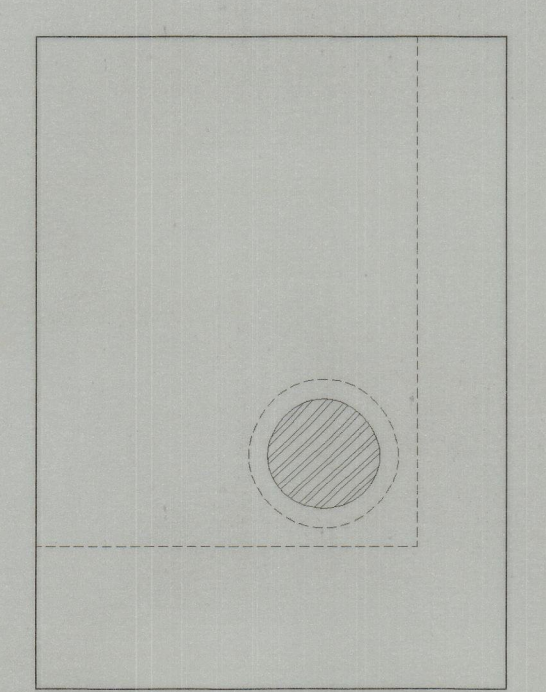

M2 - Porm. 12/horizontal

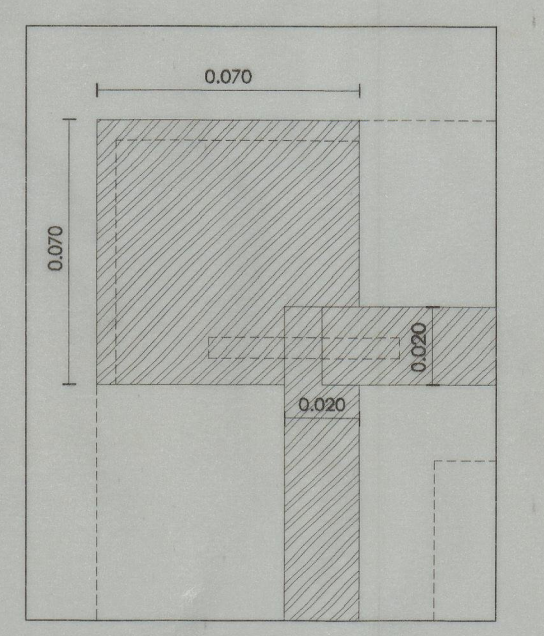

M3 - Porm. 13/horizontal

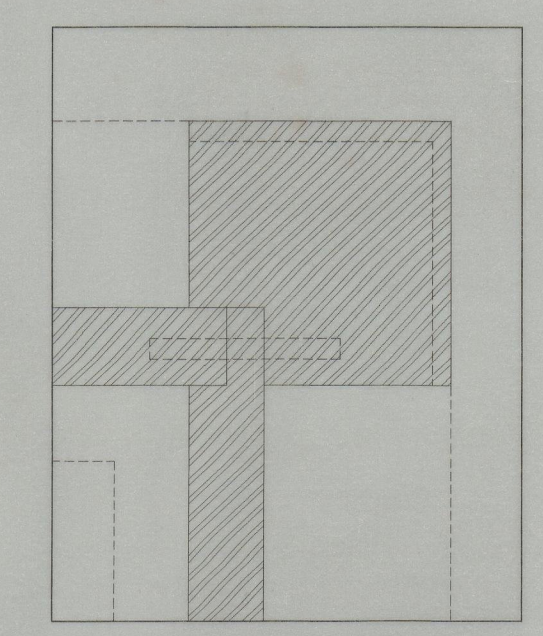

M2 - Porm. 13a/horizontal