

• MONTAGEM

• CASA EM INDIÇÃO
 • PAVIMENTO FISO SUPERIOR

TACO UNICLEAR
 MADEIRA BIA

22 mm

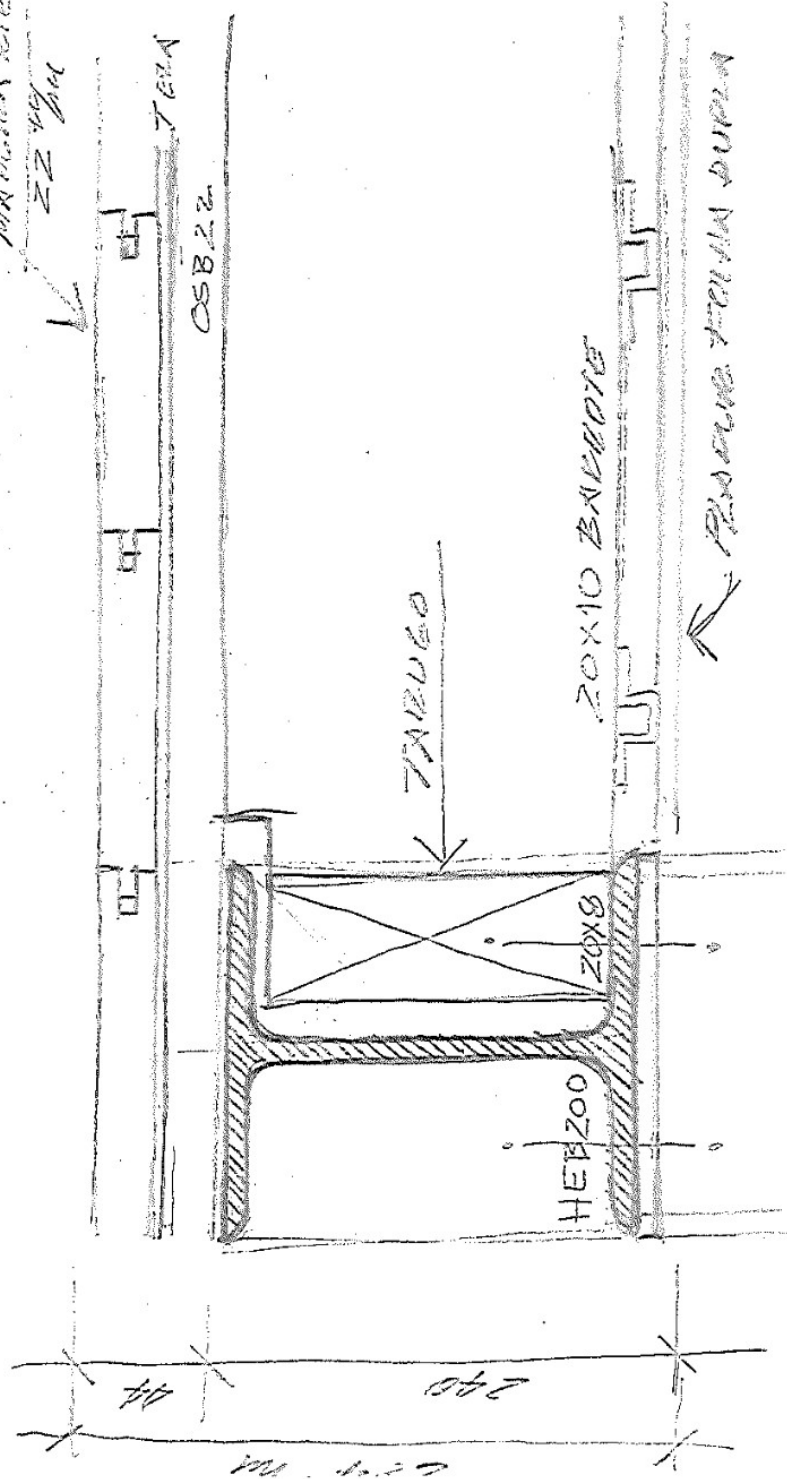

• PAVIMENTO SUPERIOR

- CASA EM INDISICAO
- ALVENARIAS EXTERIORES

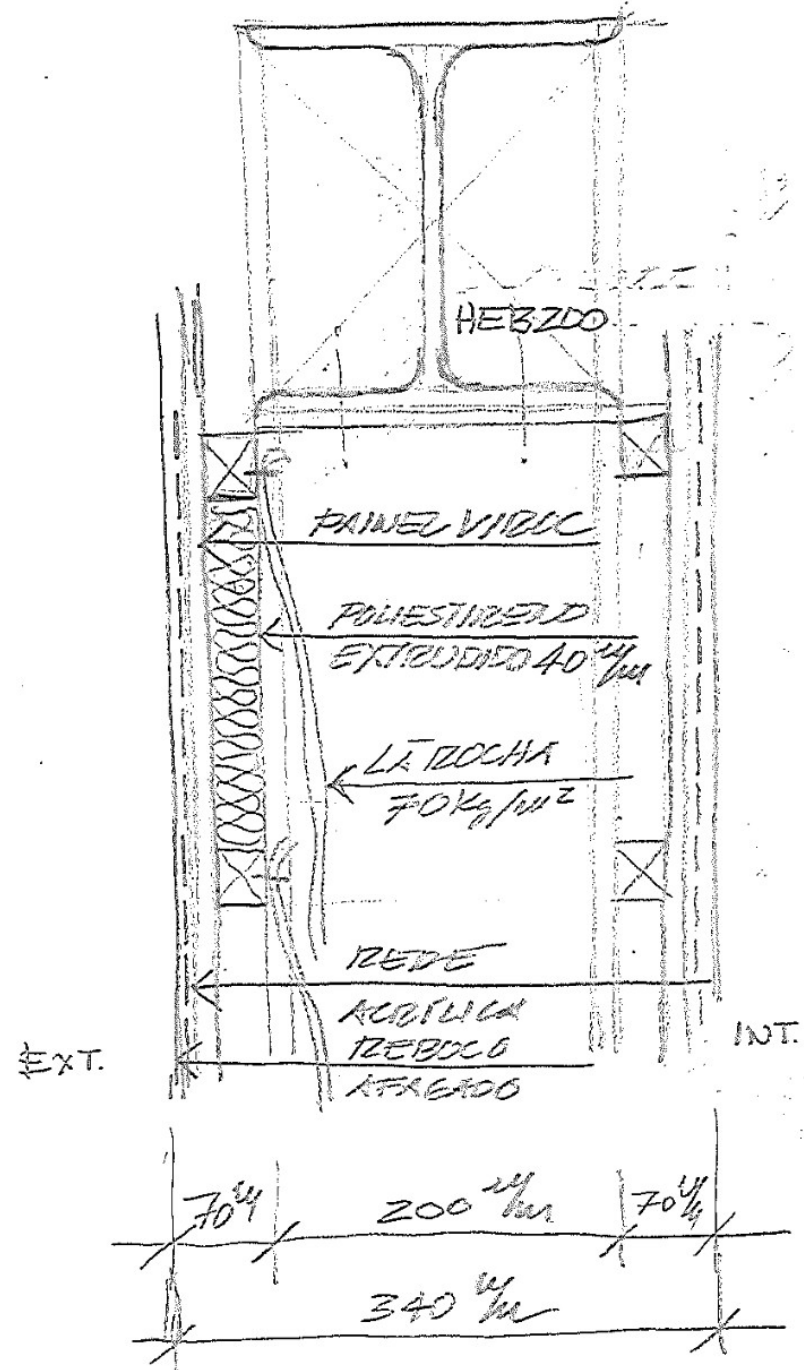
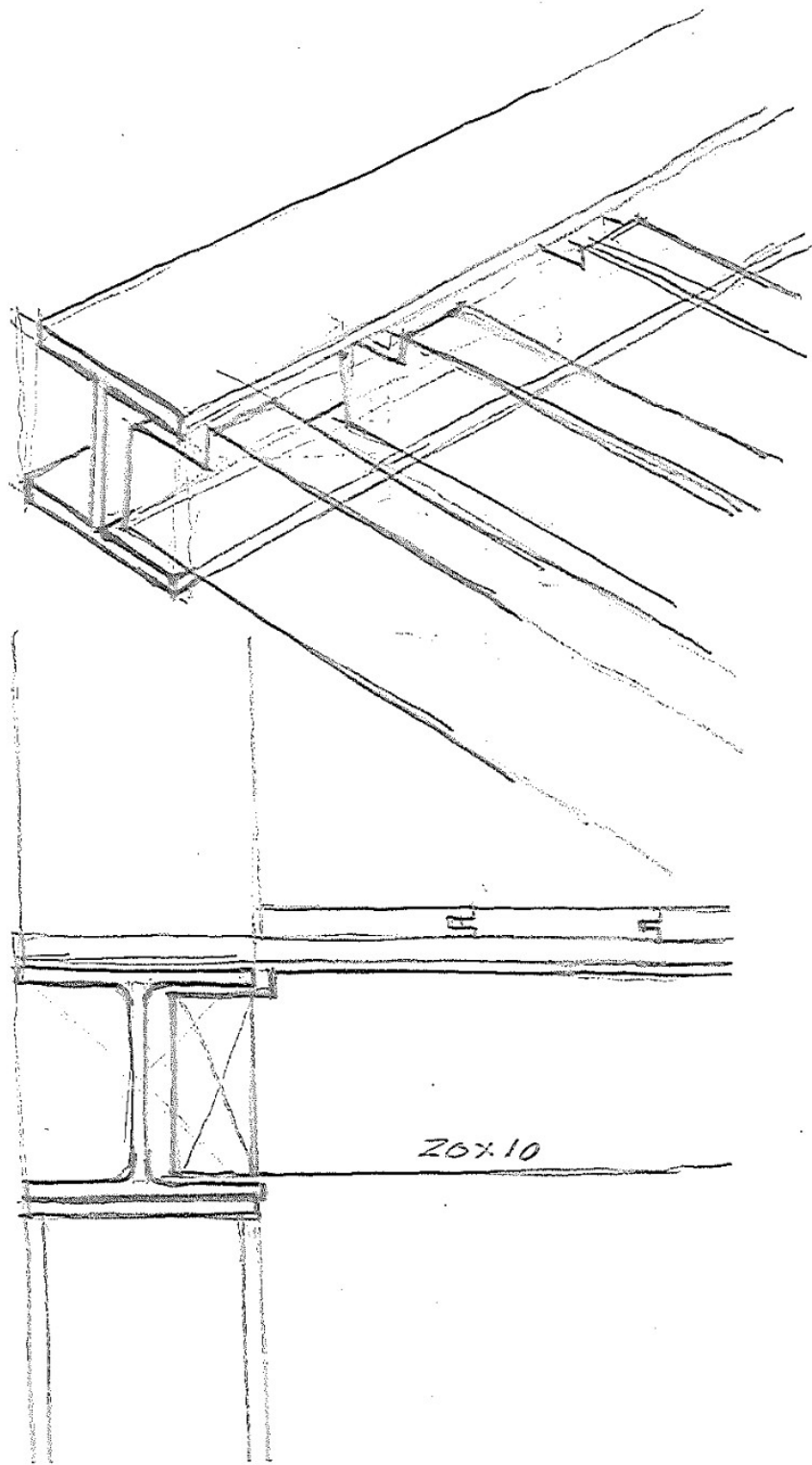

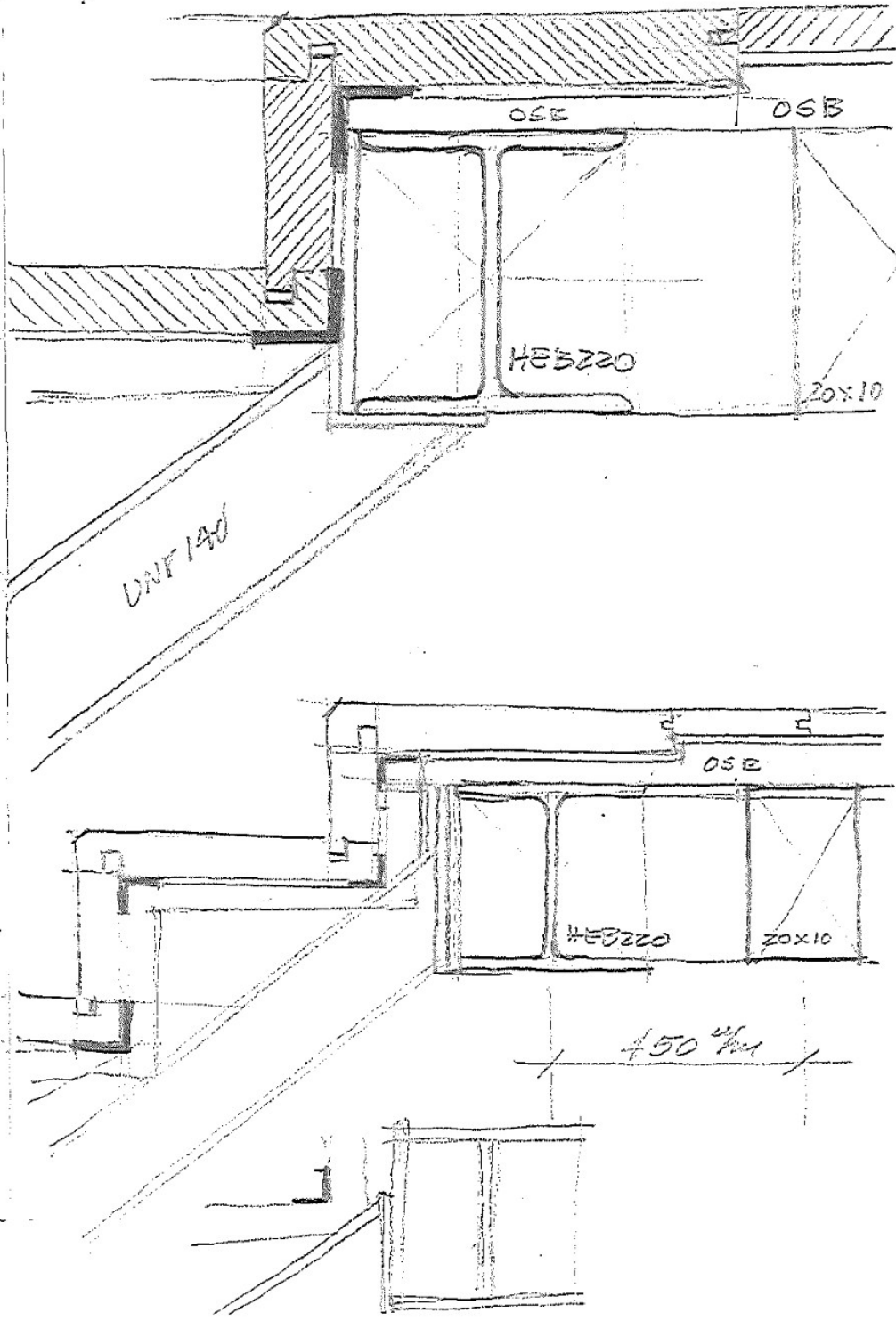
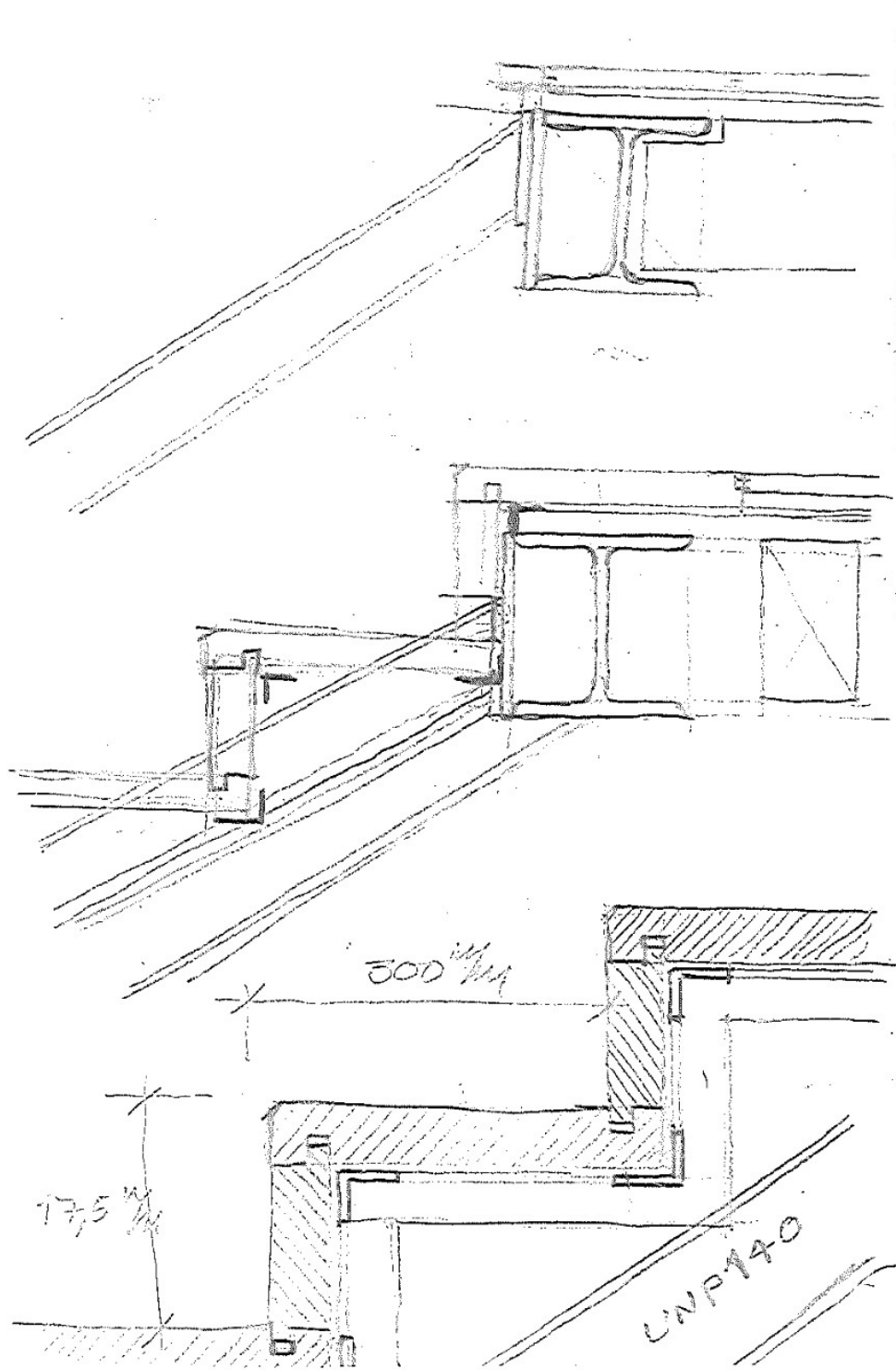

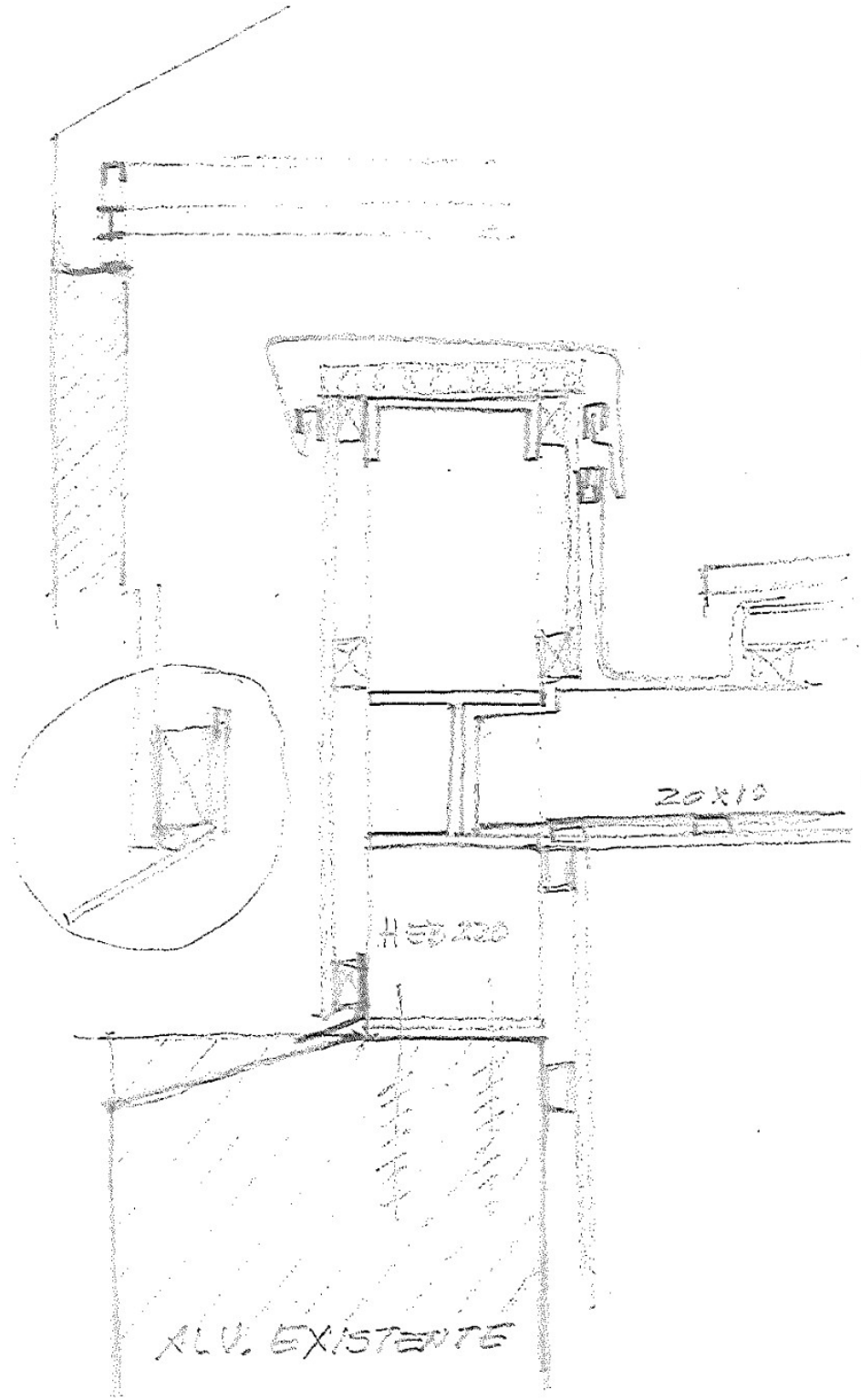
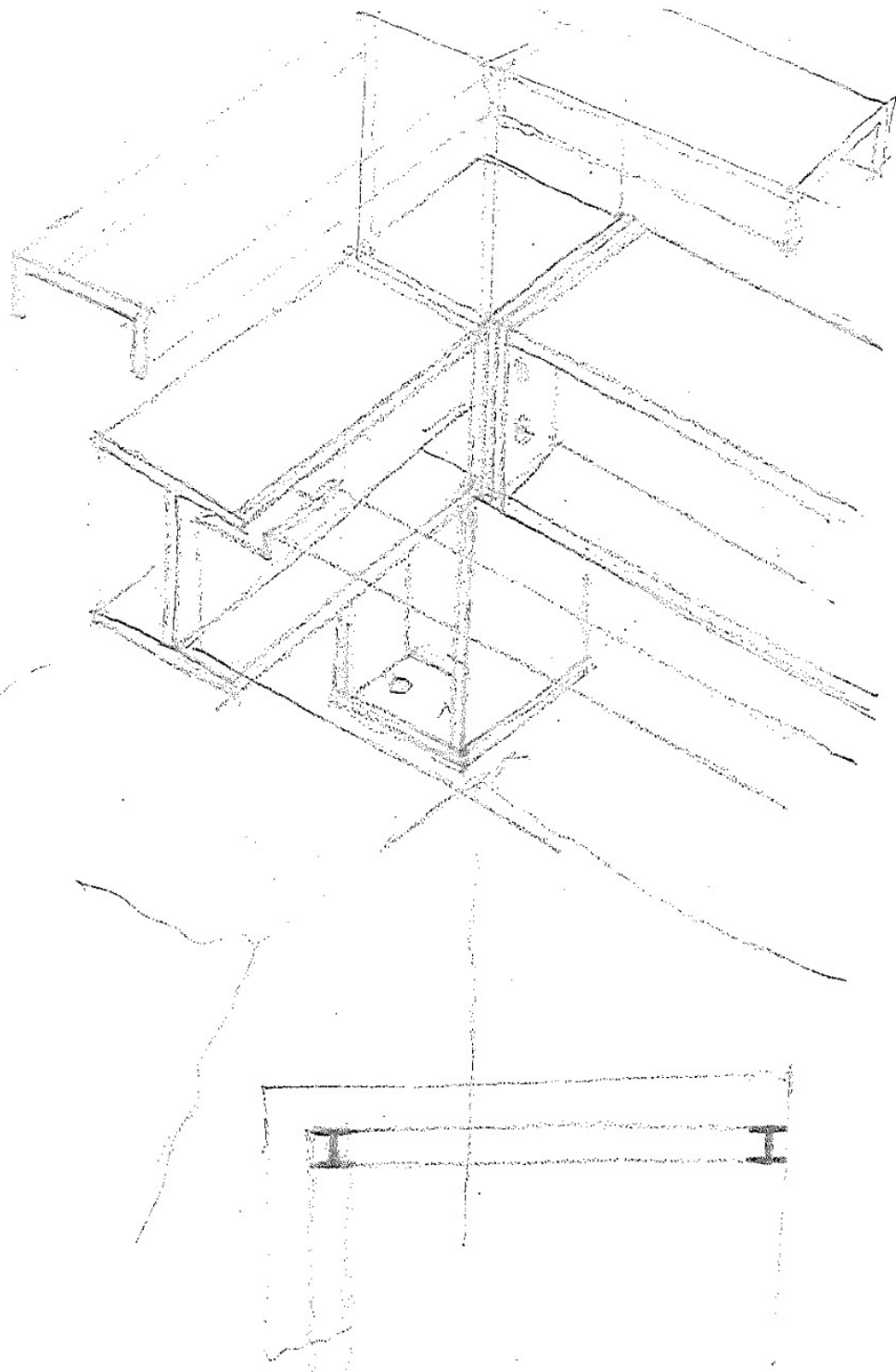

CASA DE INQUISIÇÃO
MONTEBARRAZ

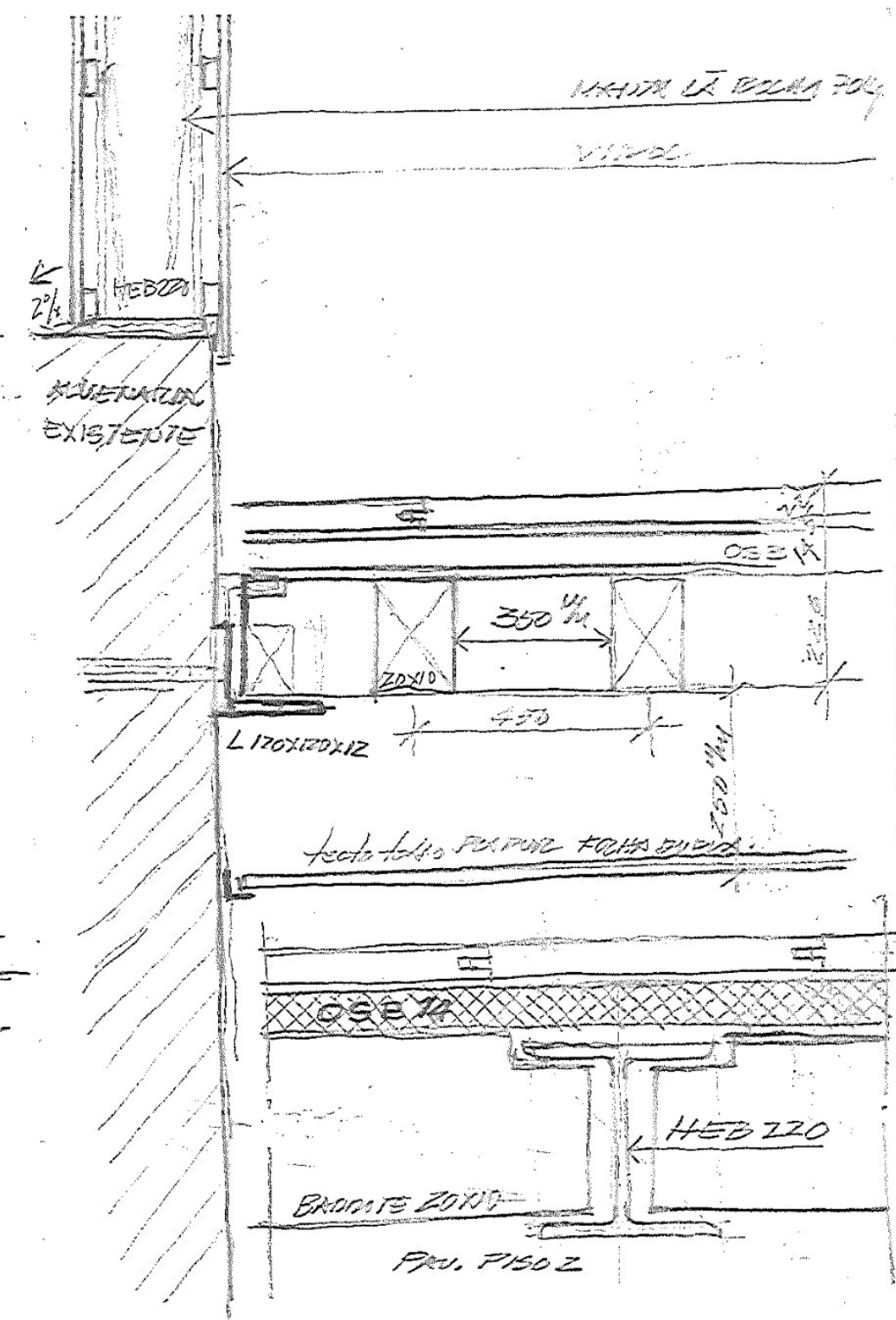
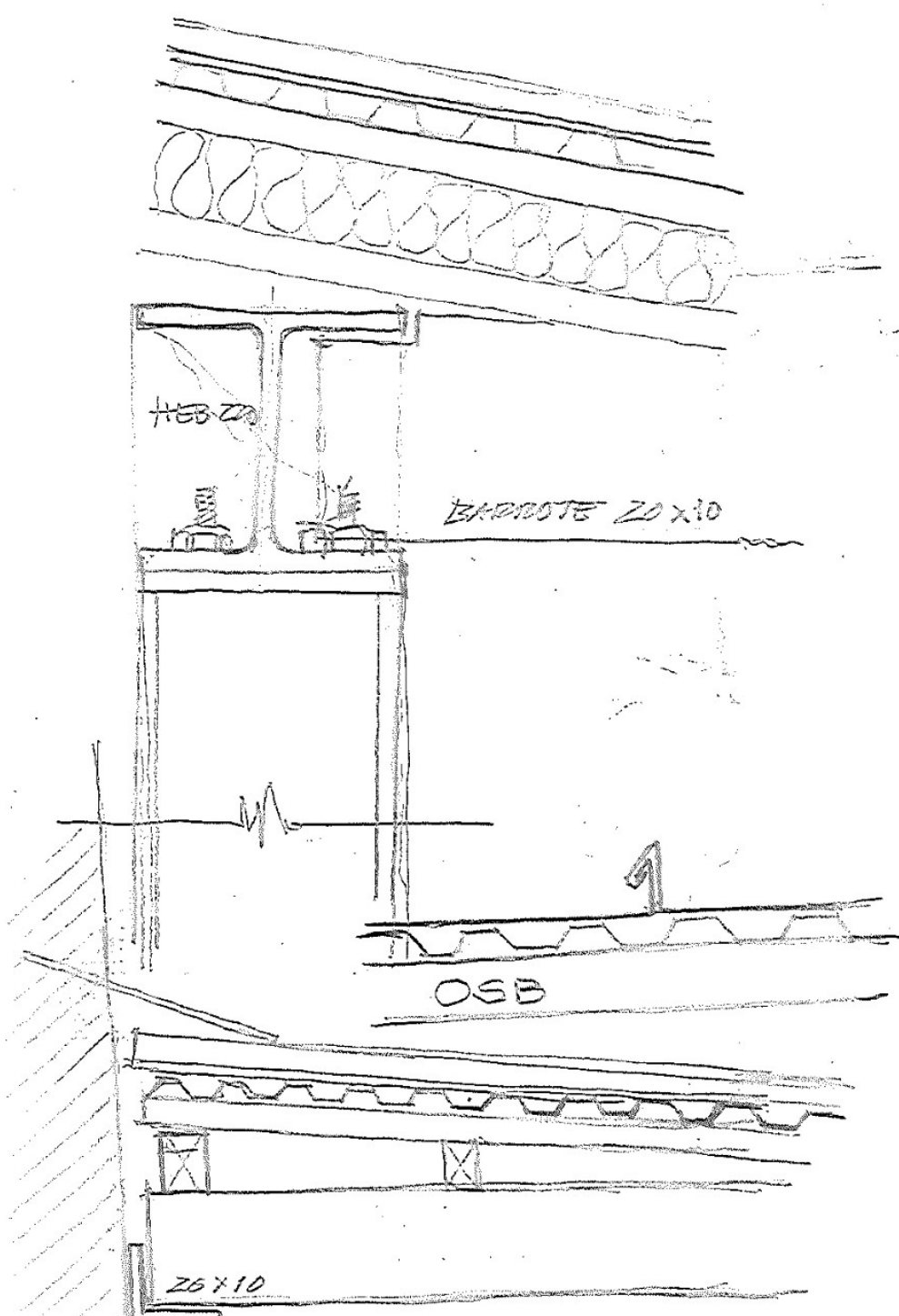

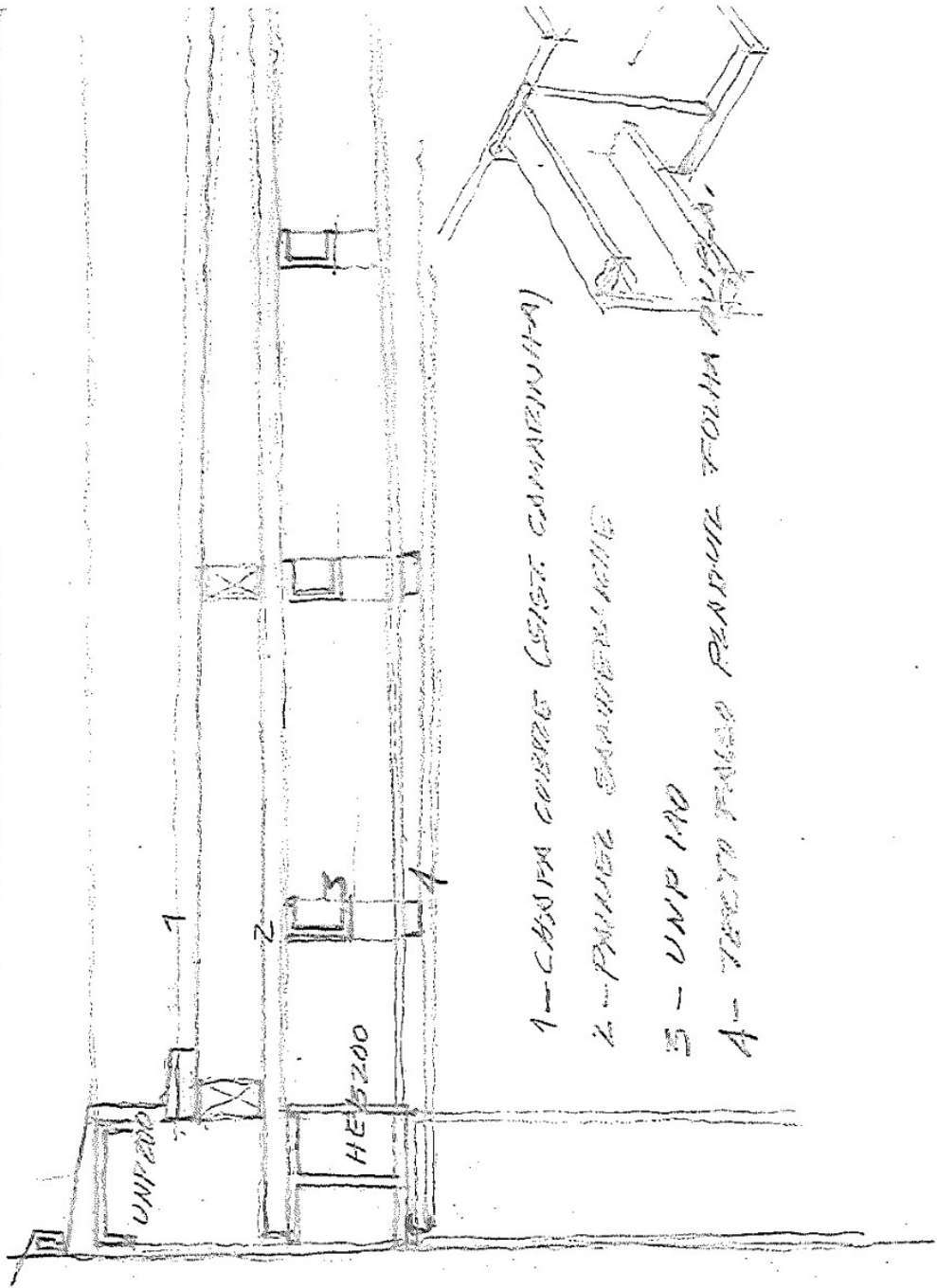

- 1- CASSA CERRA (CASSA CORRISPONDENTE)
- 2- PAVIMENTO SOTTERRANEO
- 3- UNIP 140
- 4- TRUSSO FINALE PAVIMENTO FORMA PUNTA.

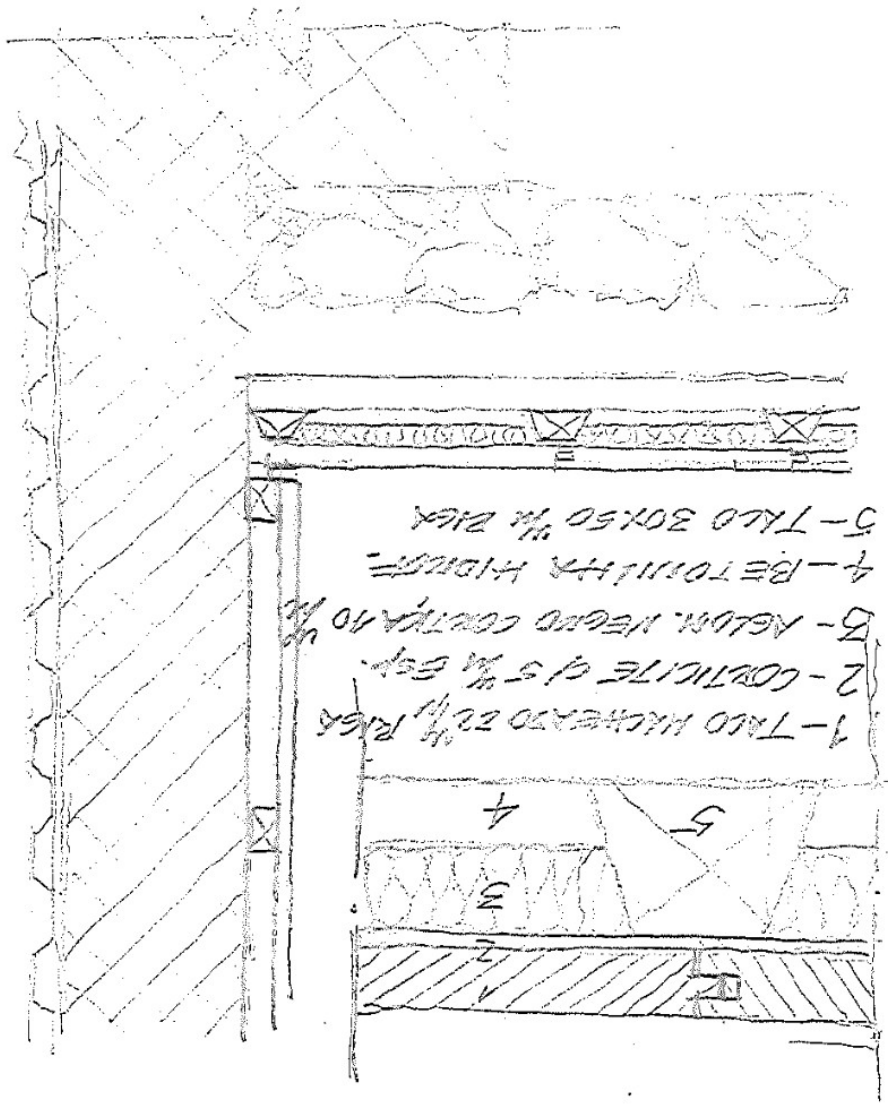

- 1- TAVO MARCHIO 22 1/2" RIGA
- 2- COFFRITTE di 5 1/2" ESP.
- 3- ALUM. NEGRO CORRADO 10 1/2"
- 4- BENTONITE HIGROSC.
- 5- TAVO 30x150 1/2" RIGA

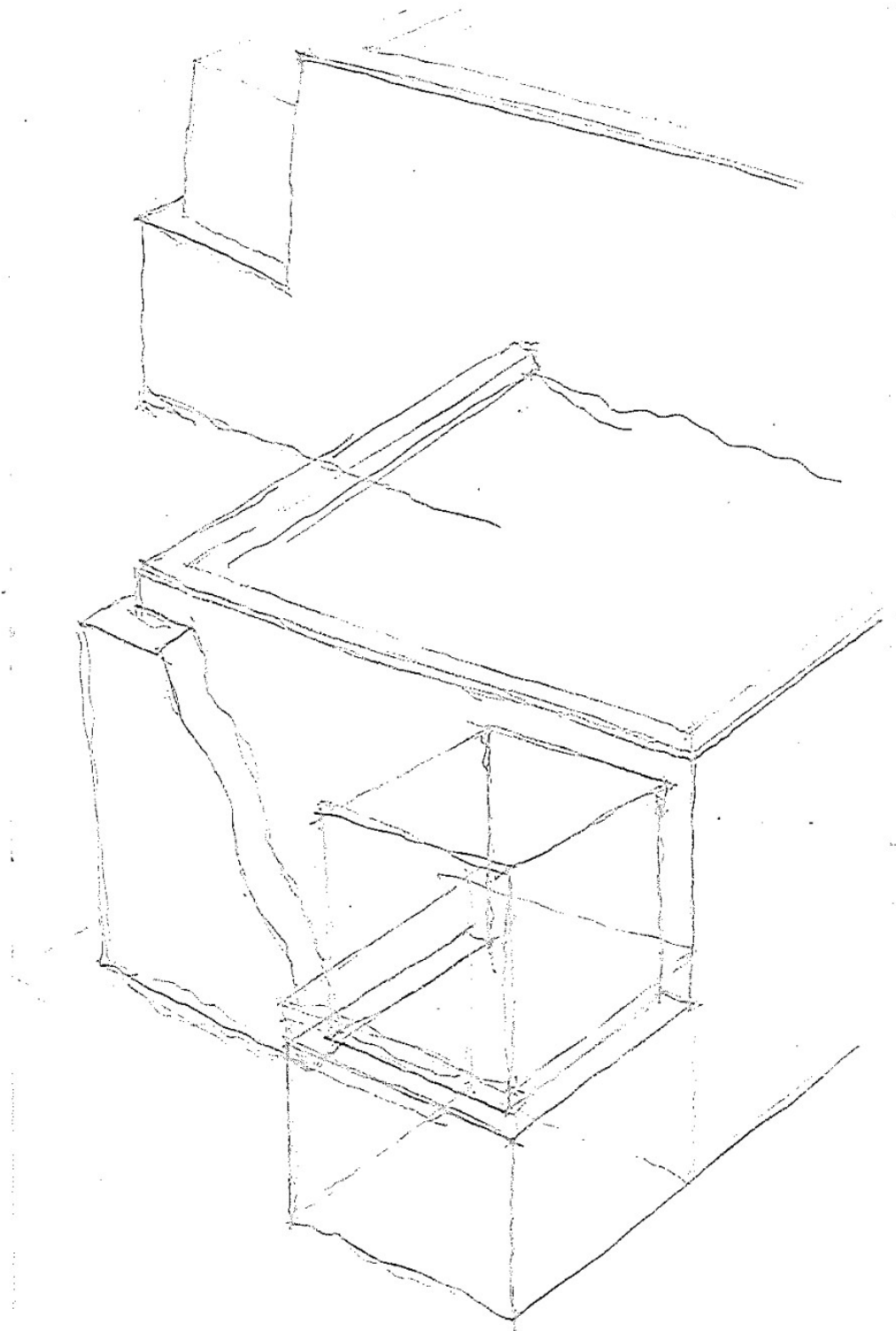
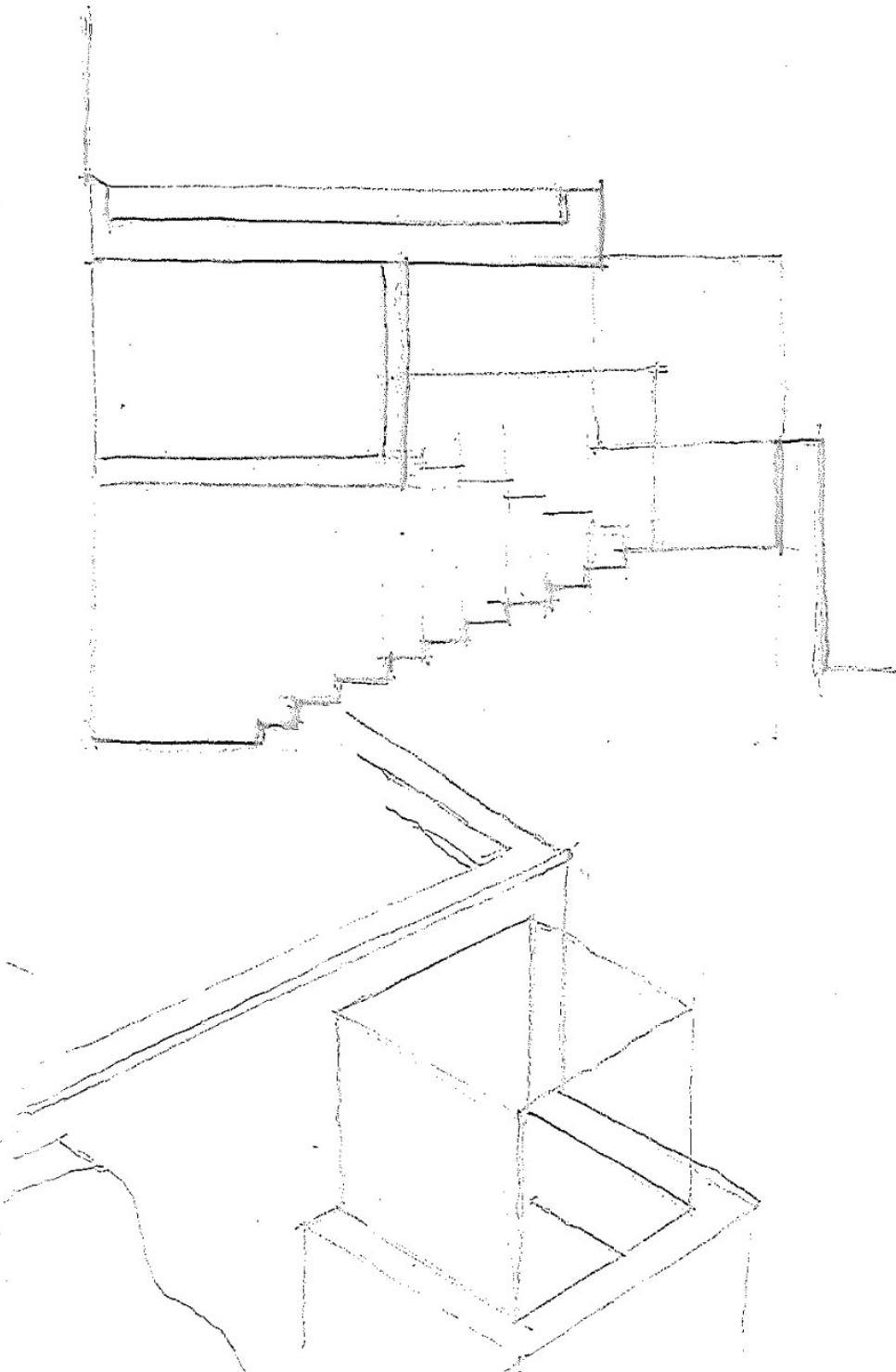

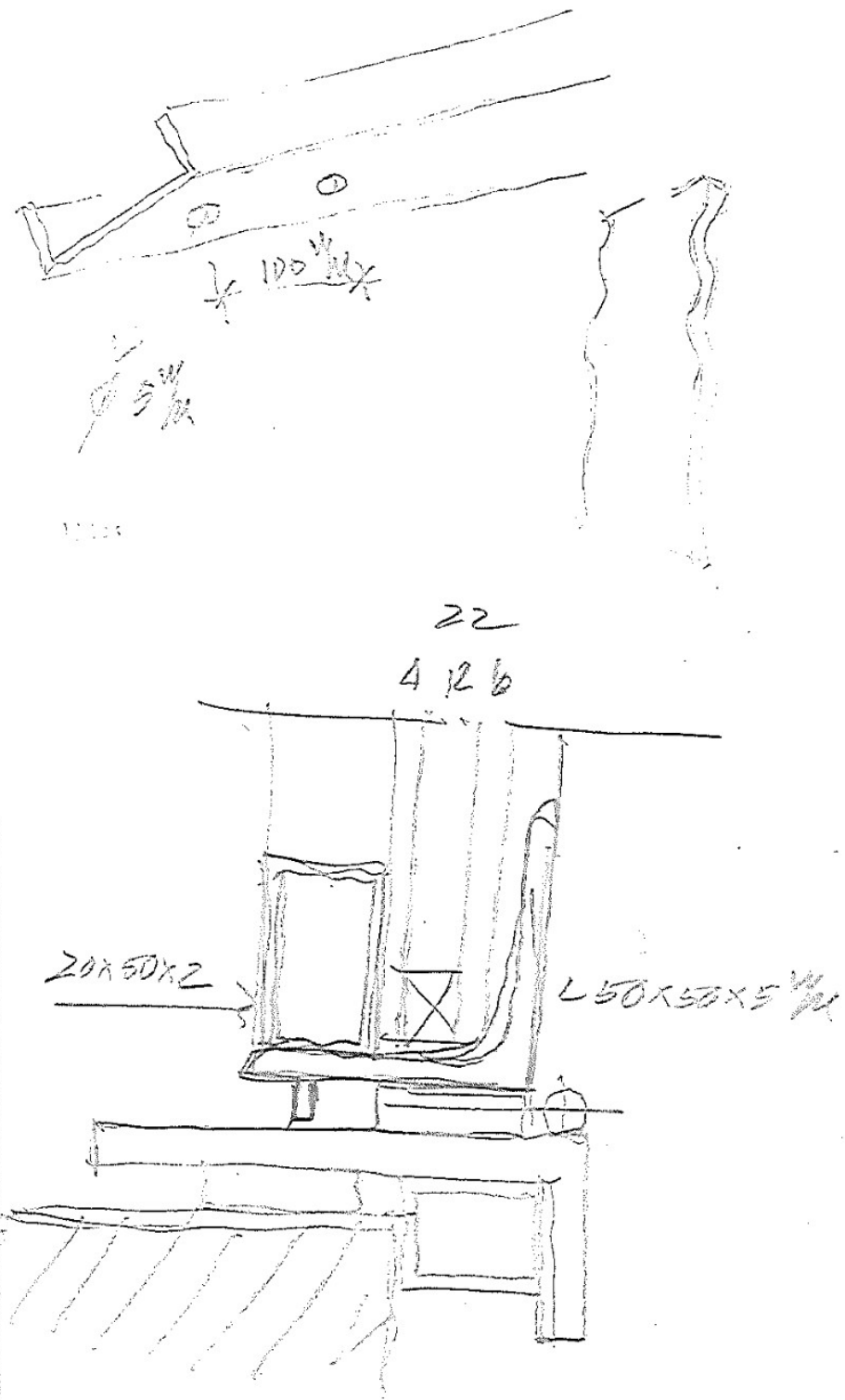
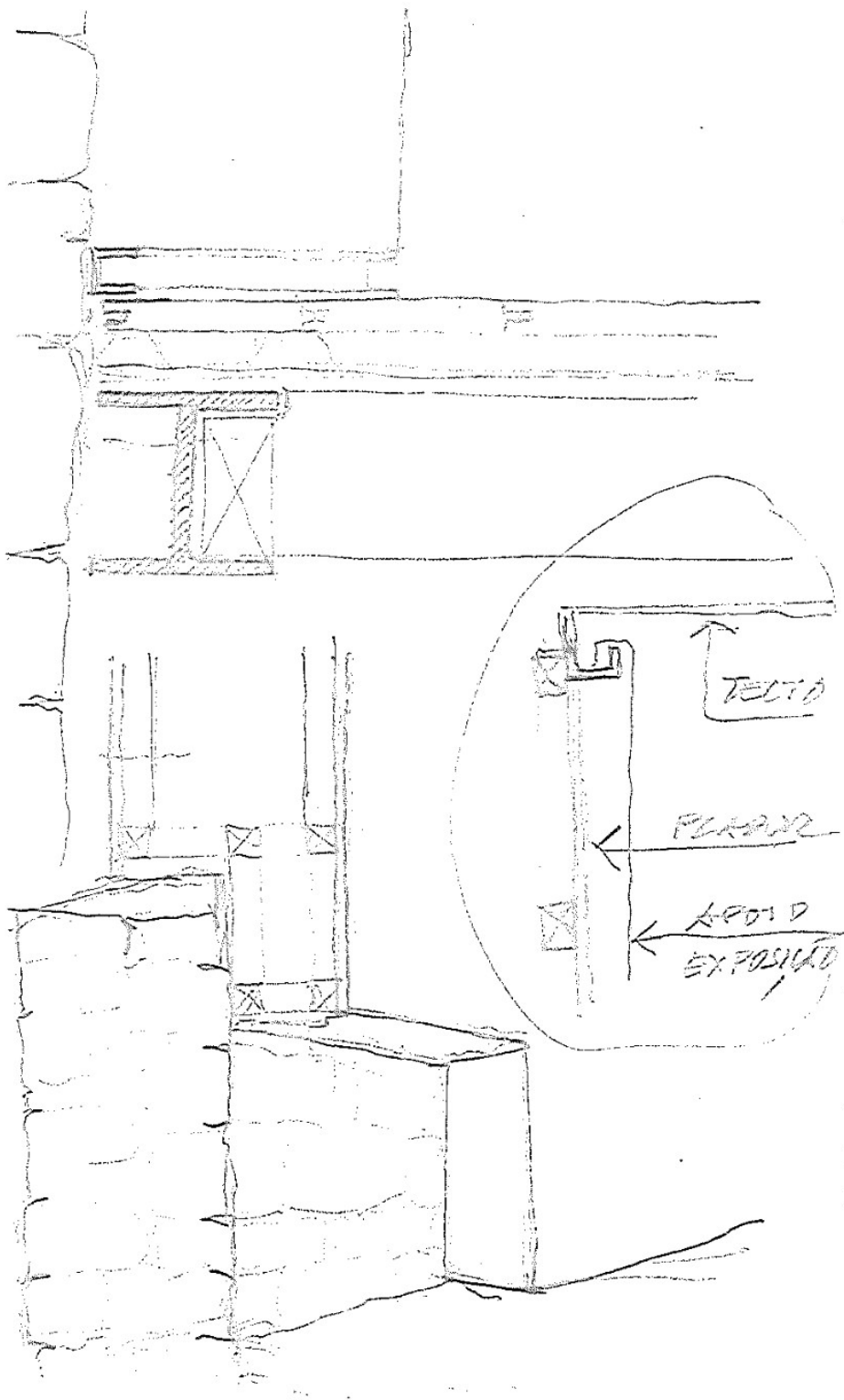

- CALA EM INQUISICAO
- ALVENARIAS EXTERIORES

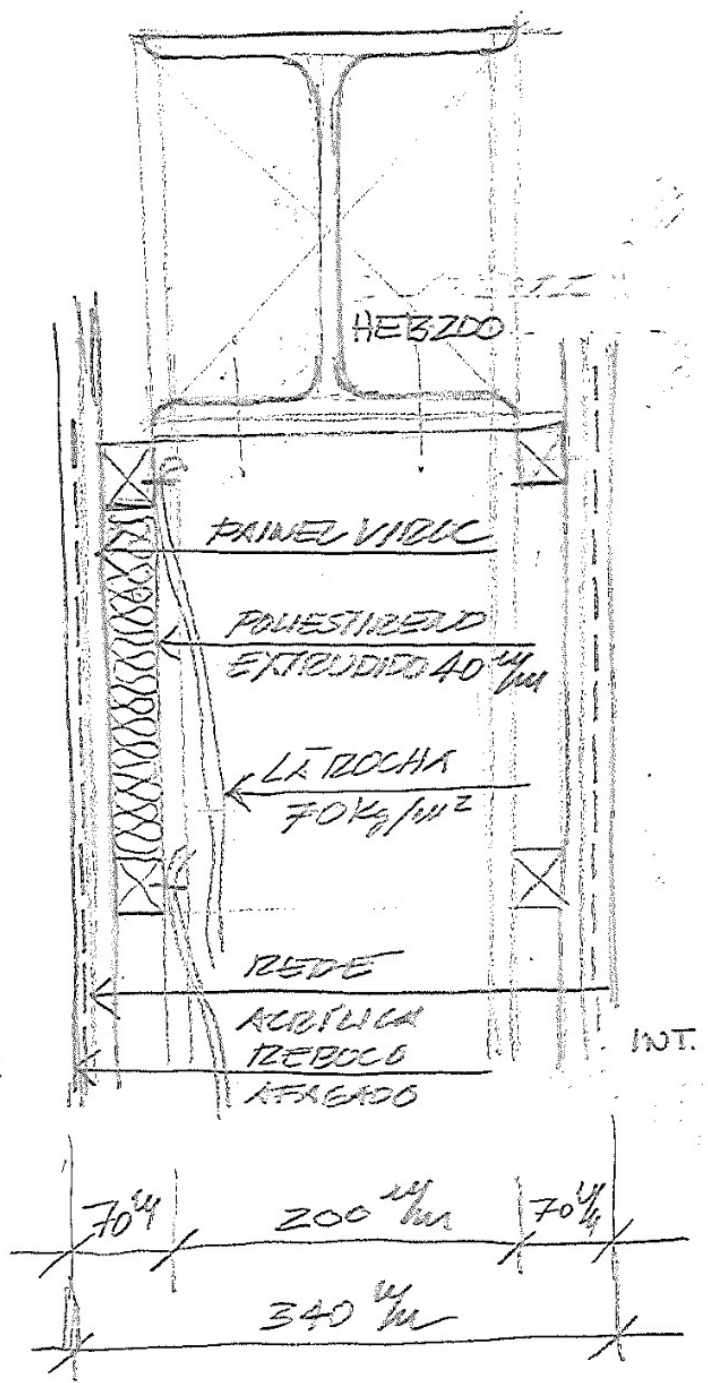
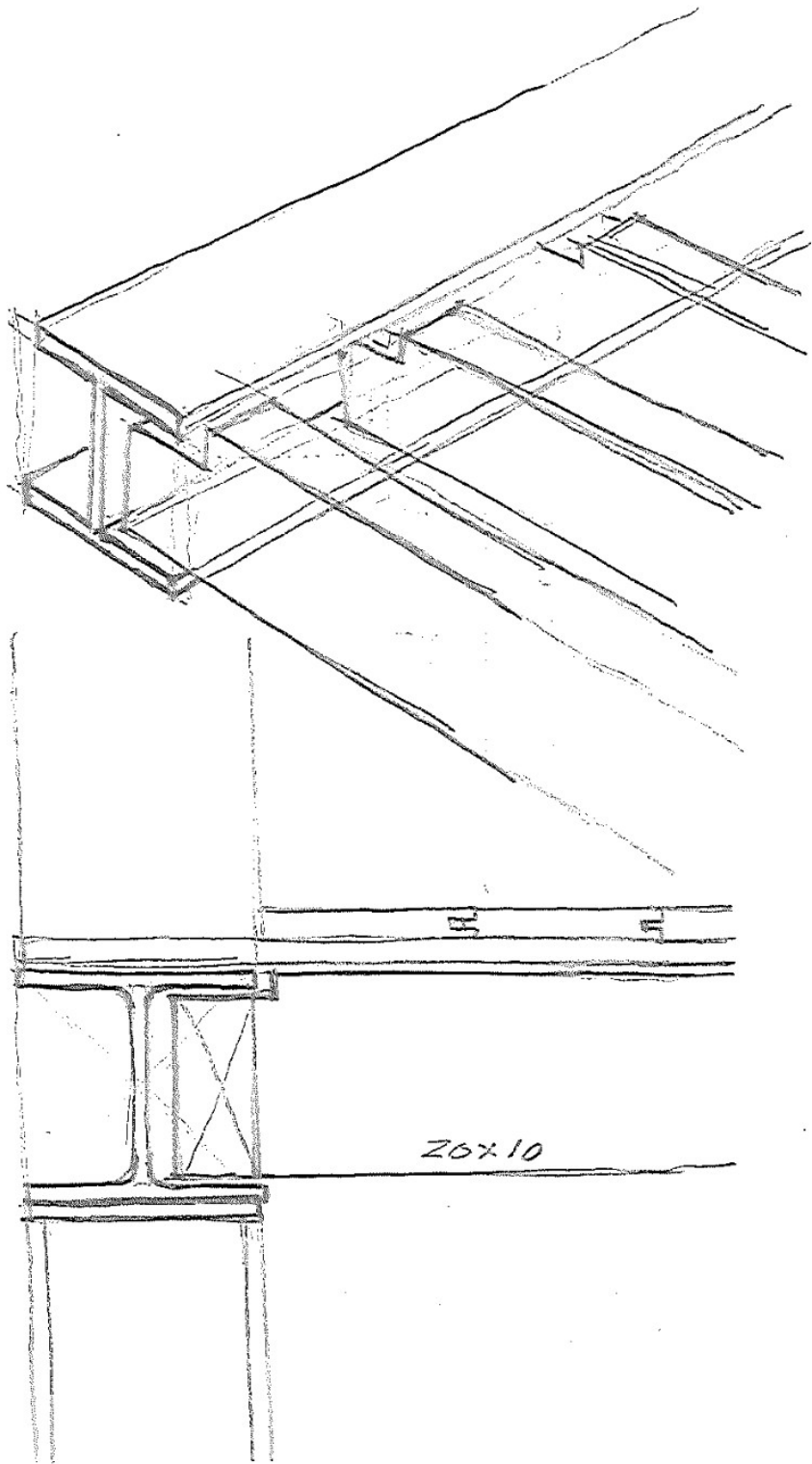

CASA DA INQUIÇÃO
MONSIEZ

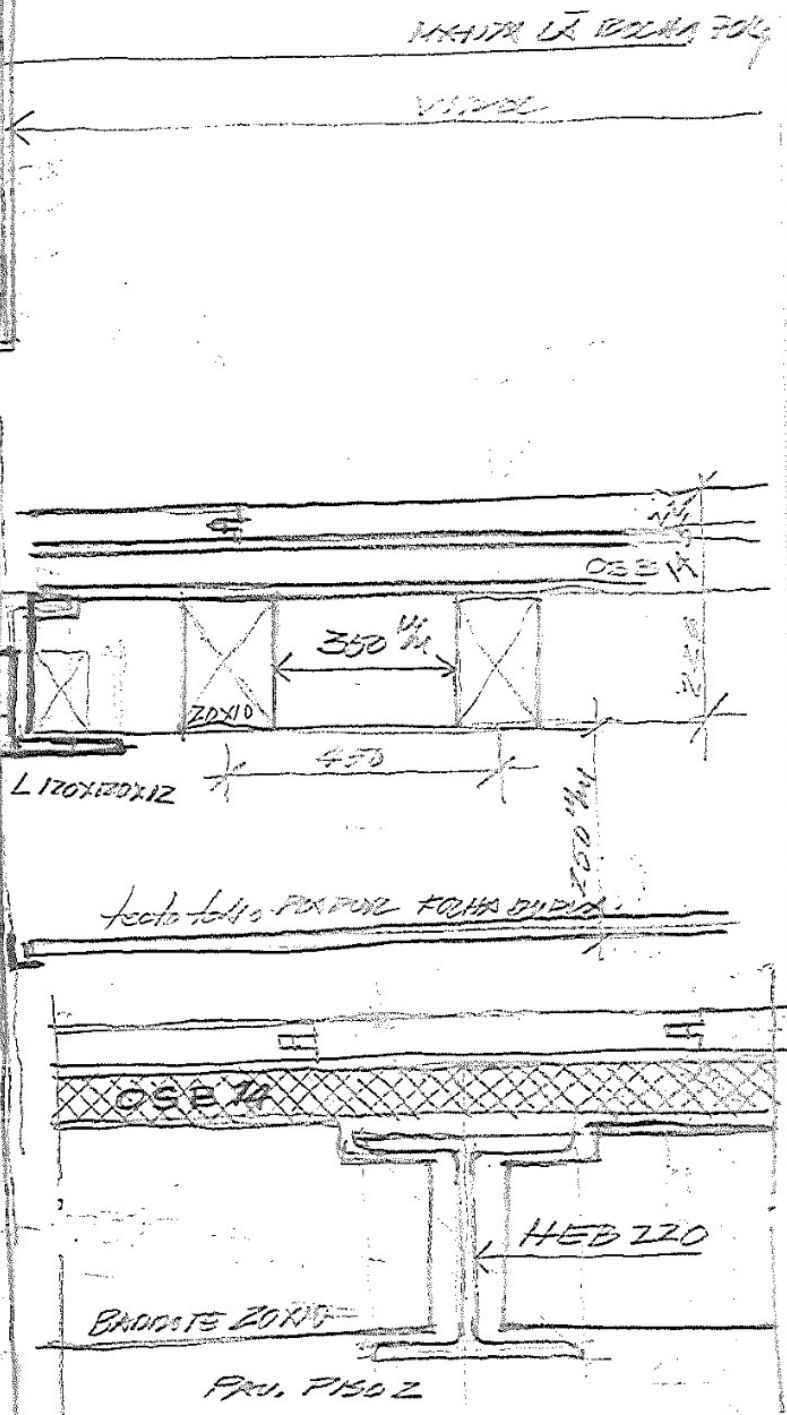
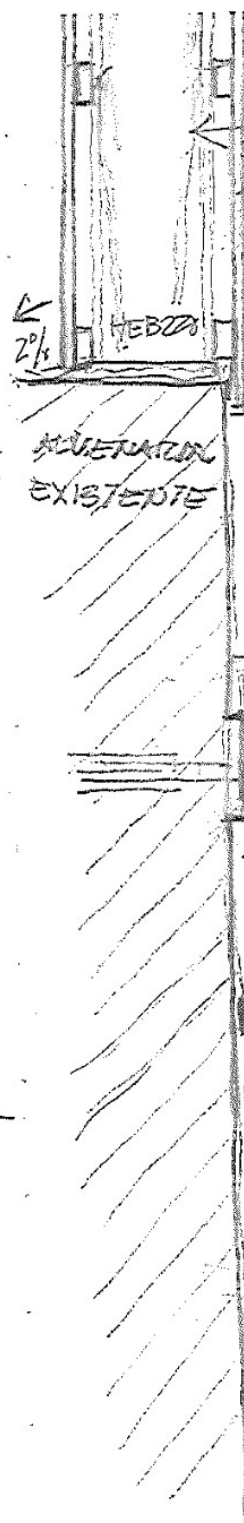
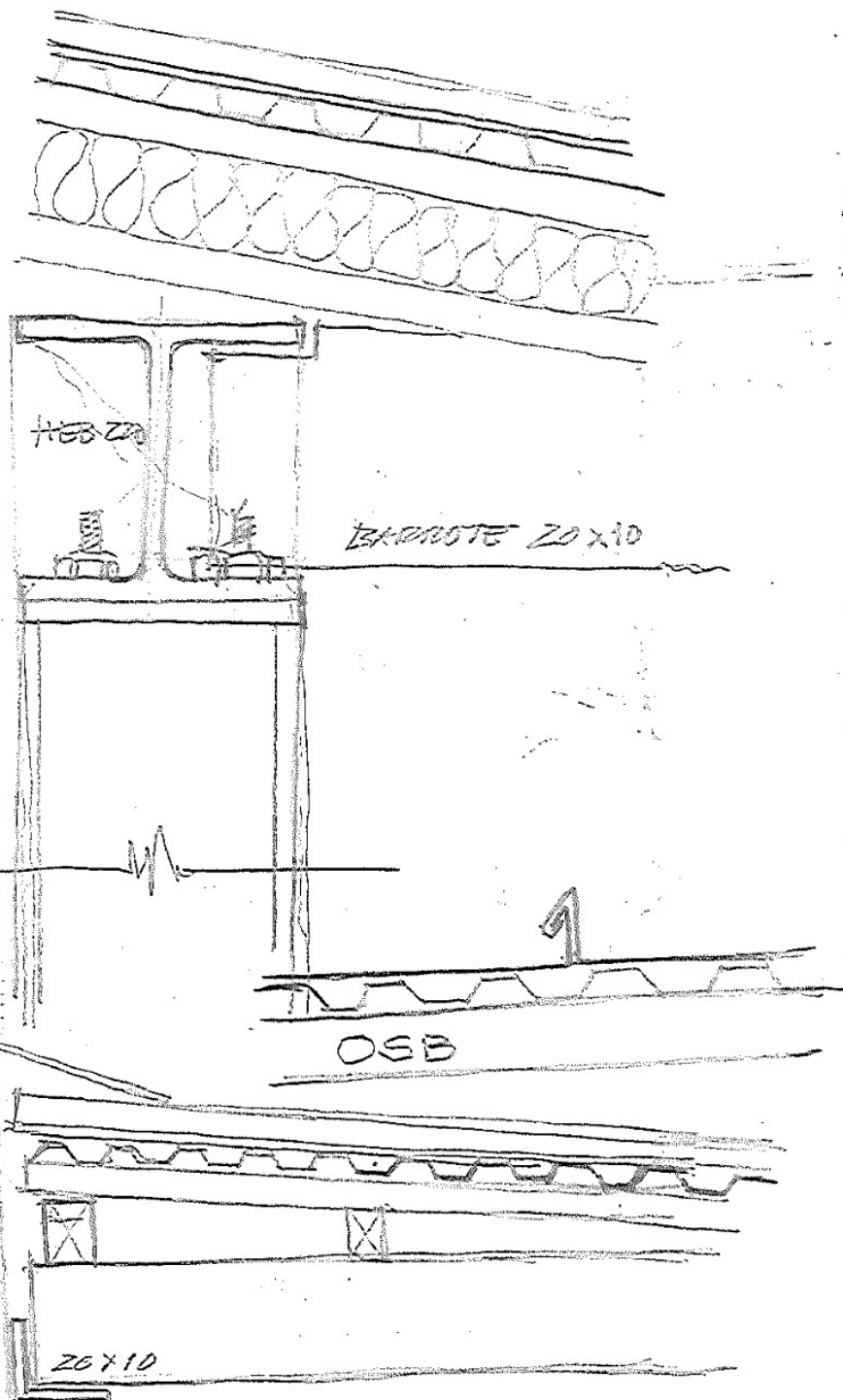

Fru. PISO 2

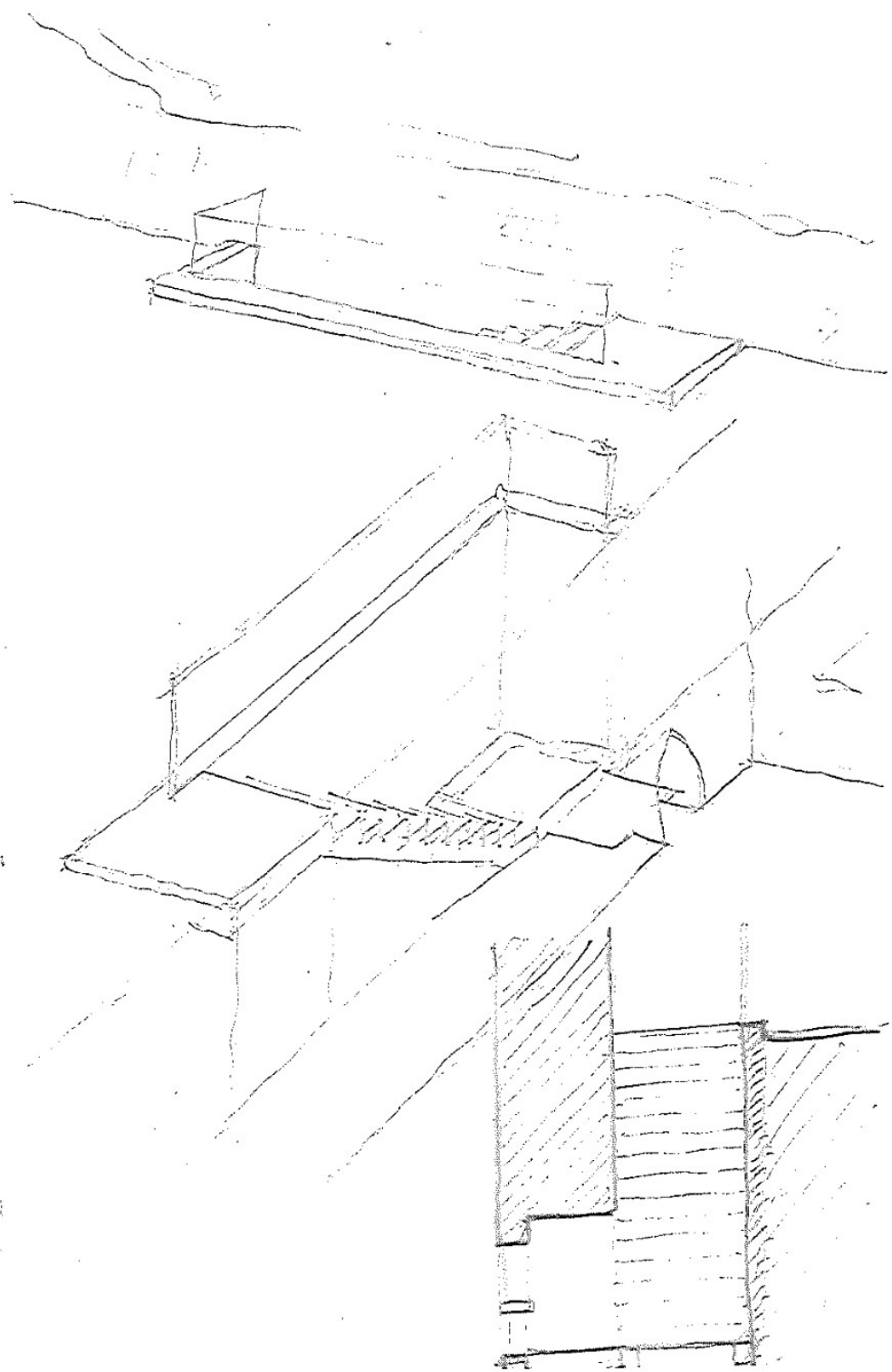
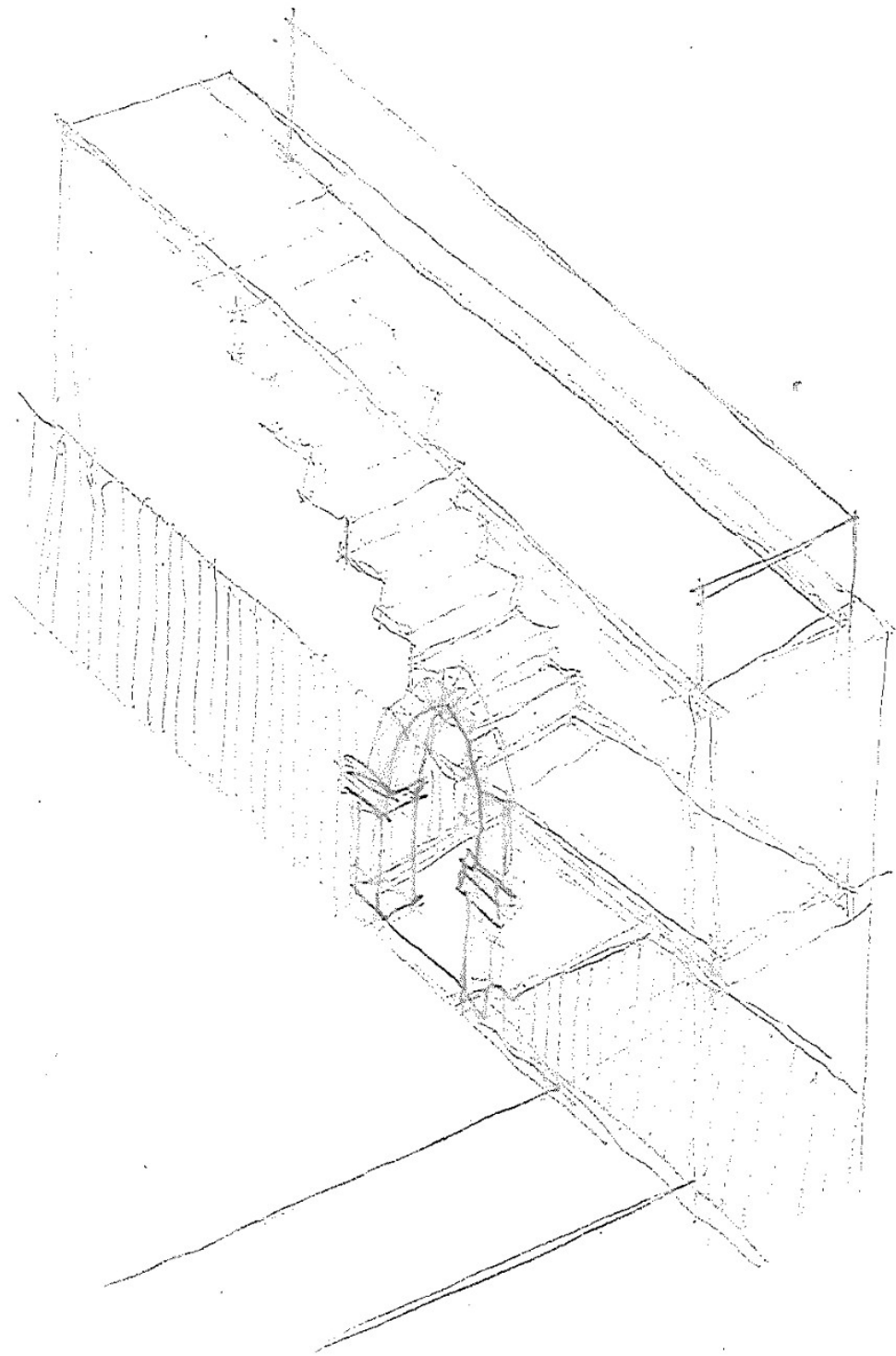

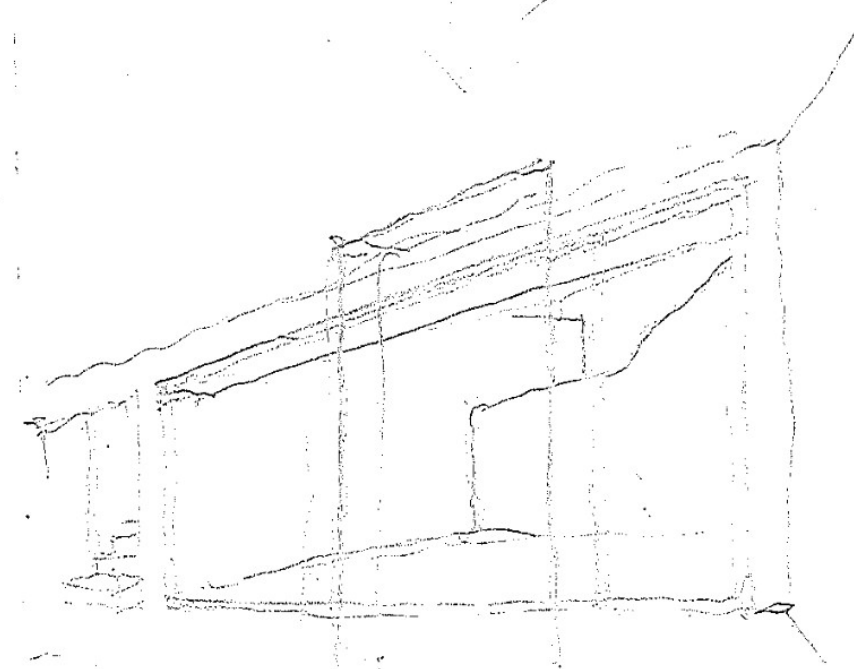
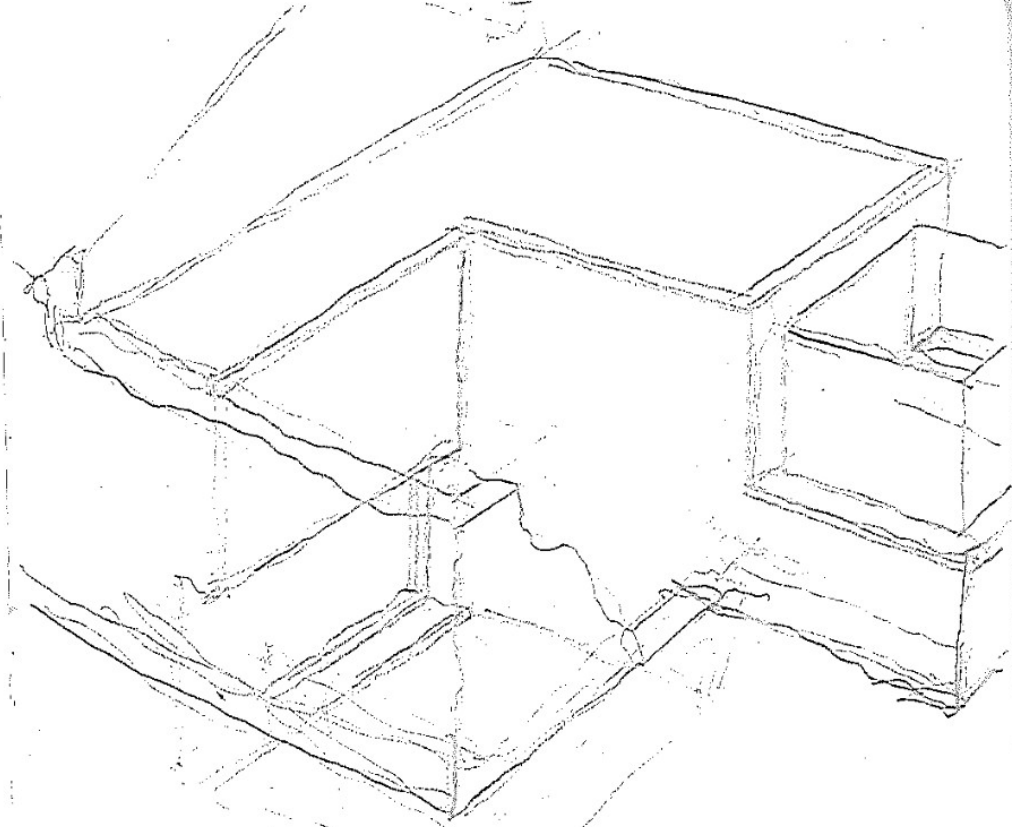
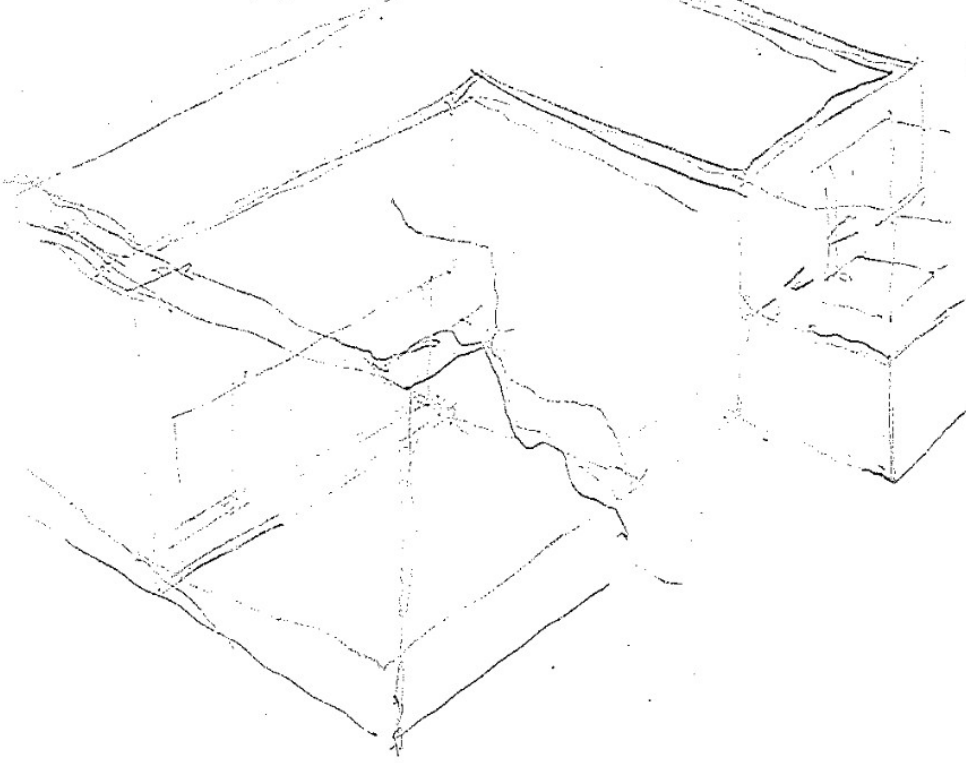
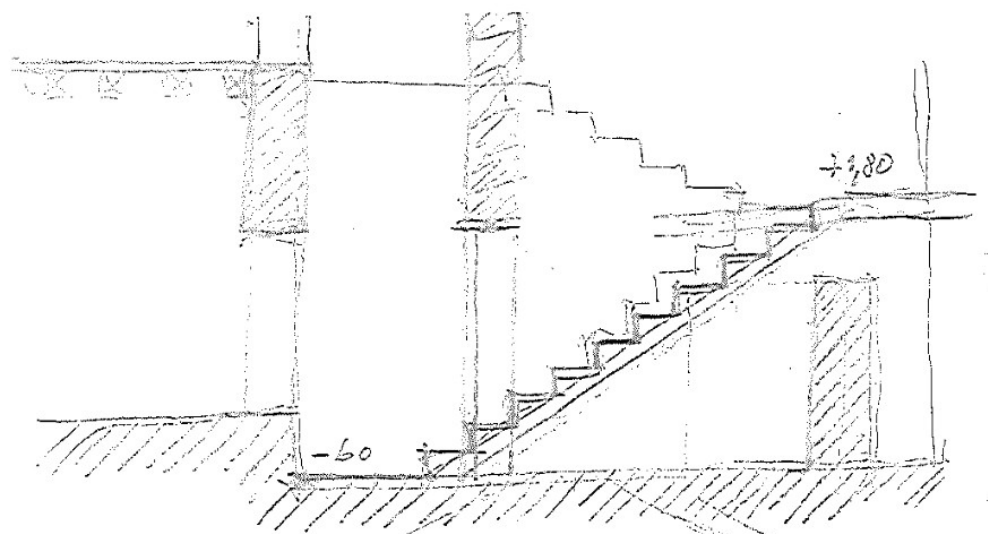

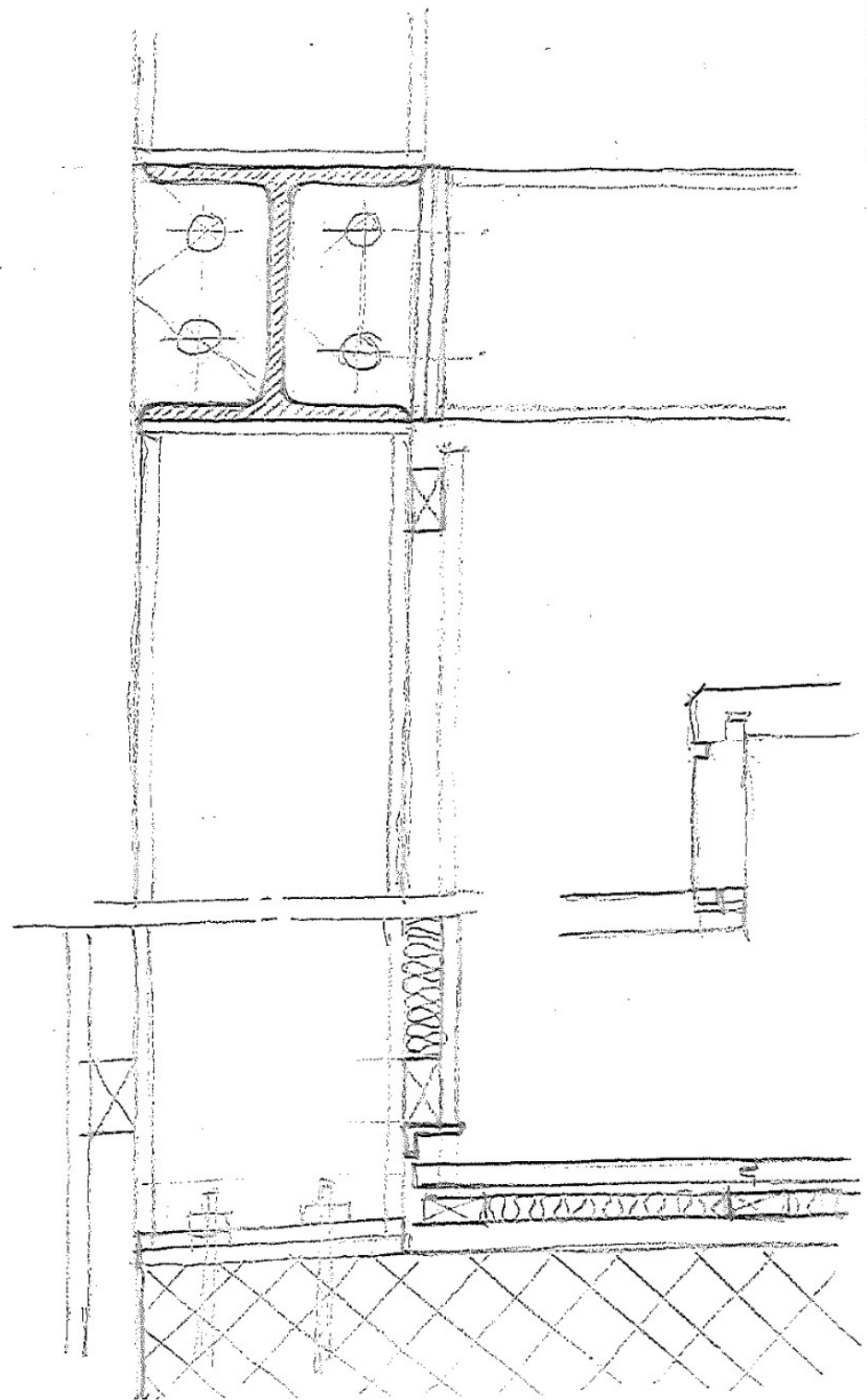
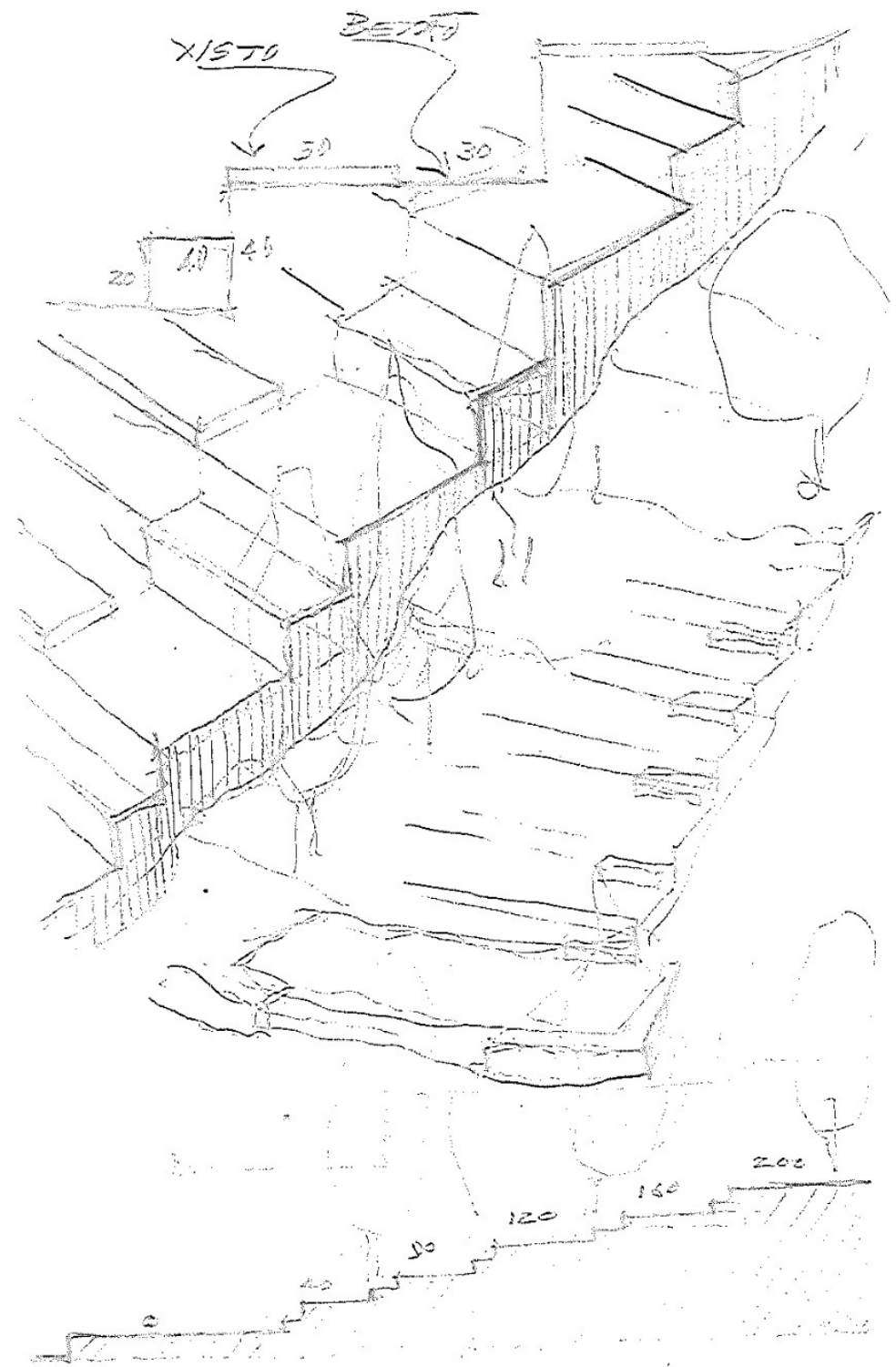

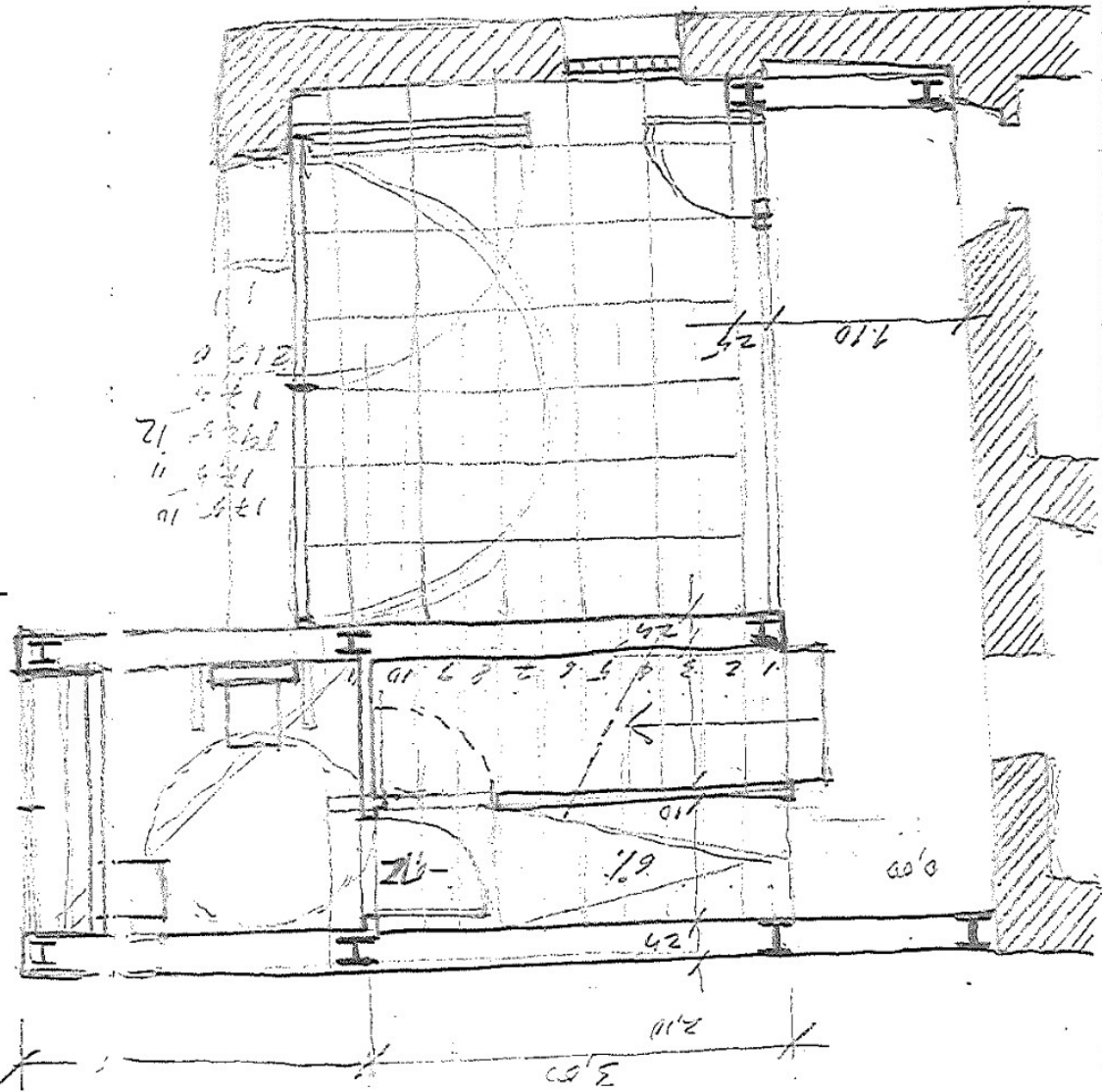
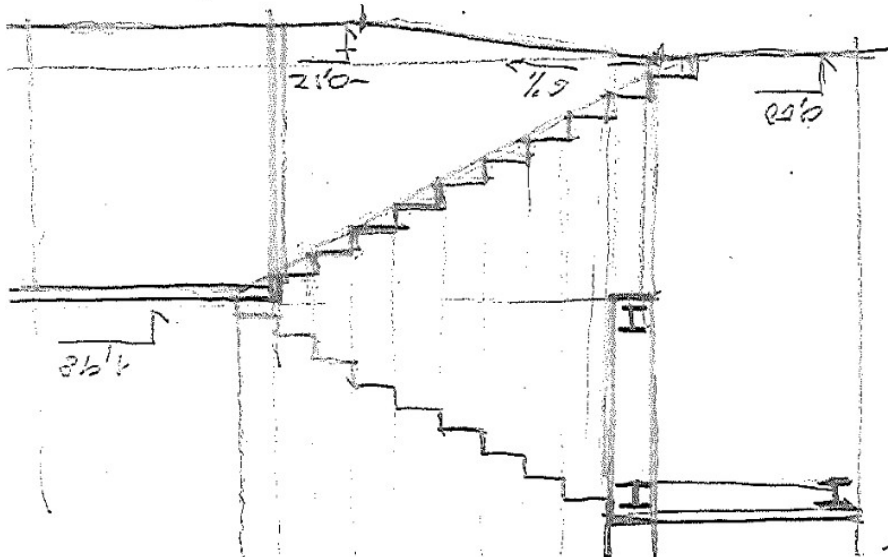
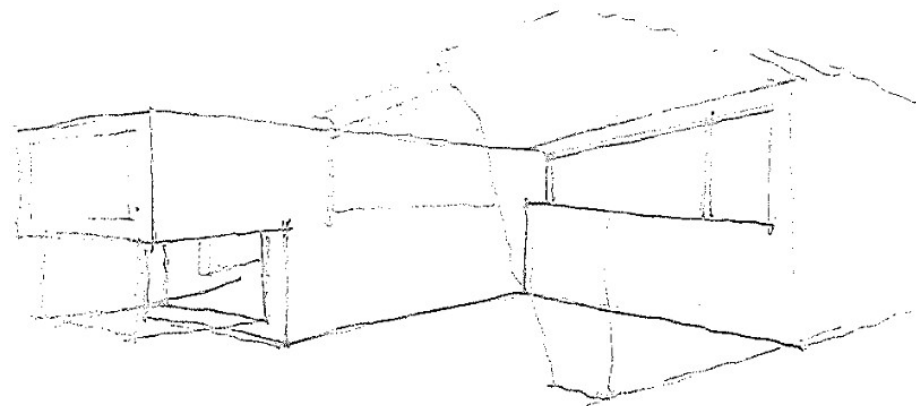
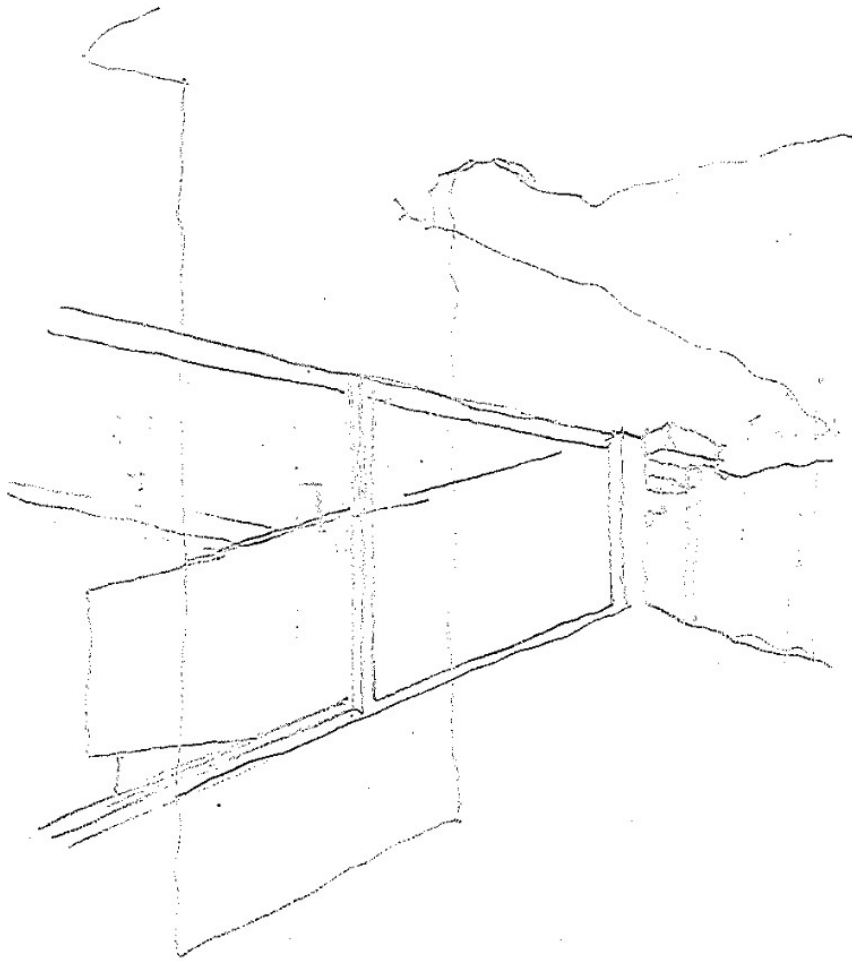

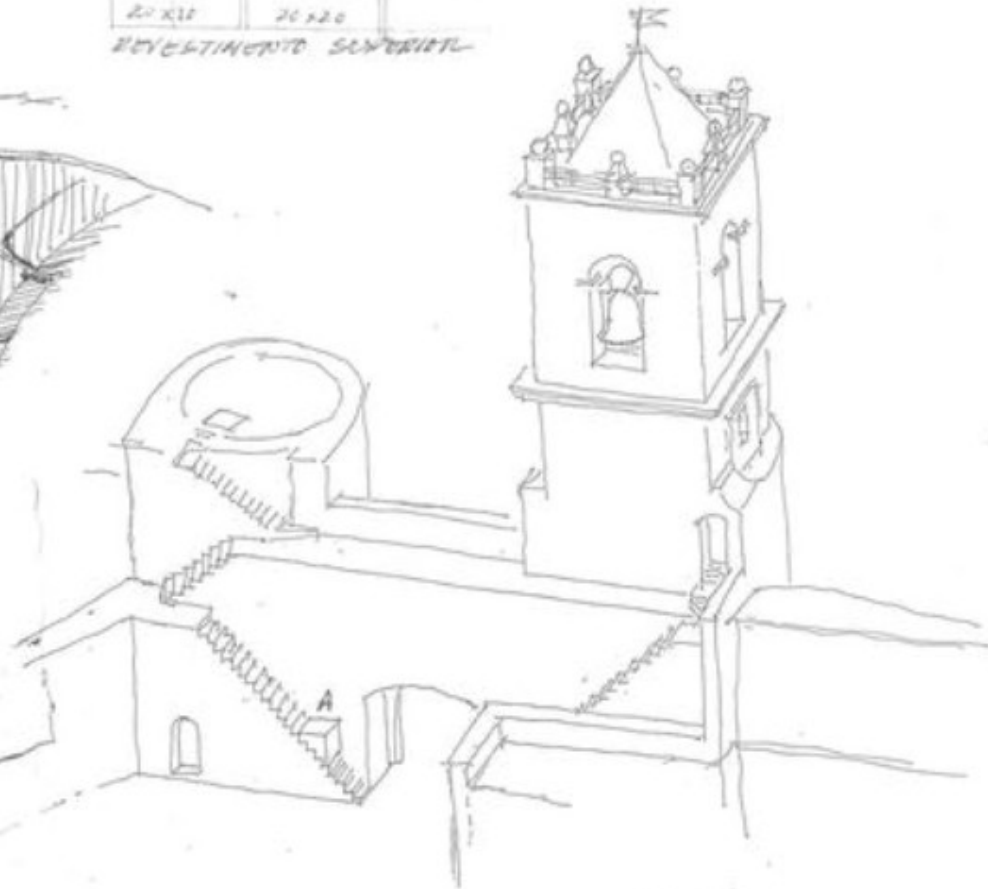
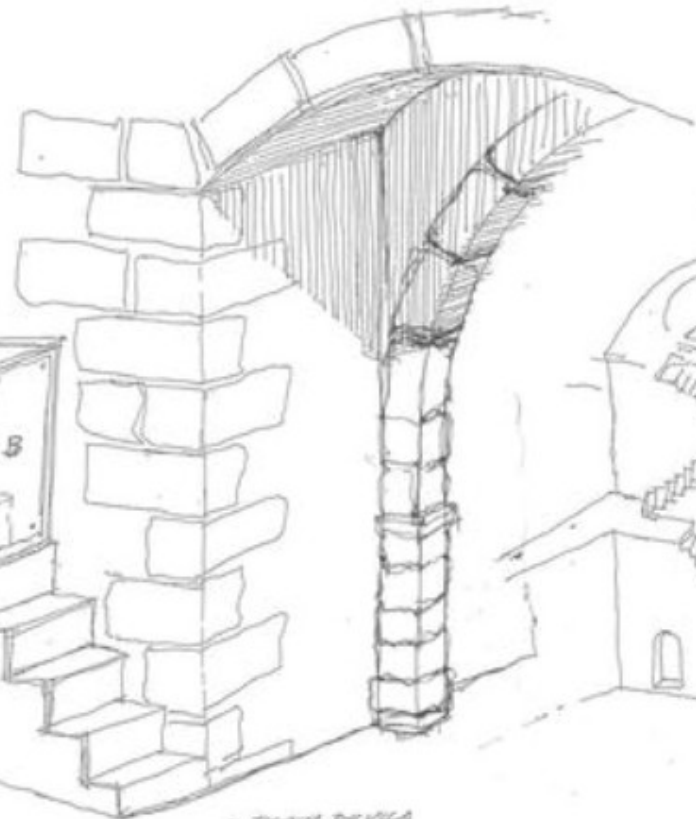
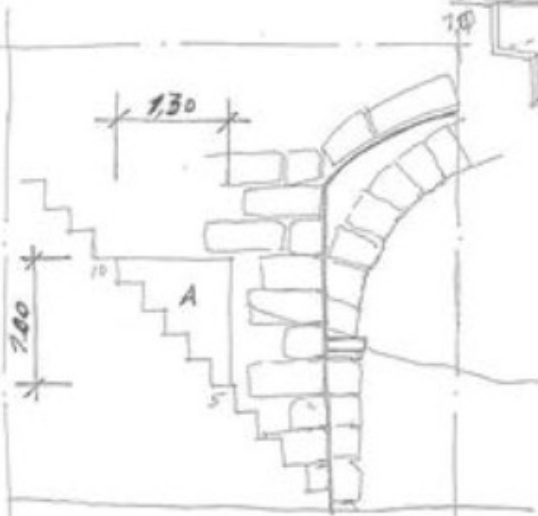
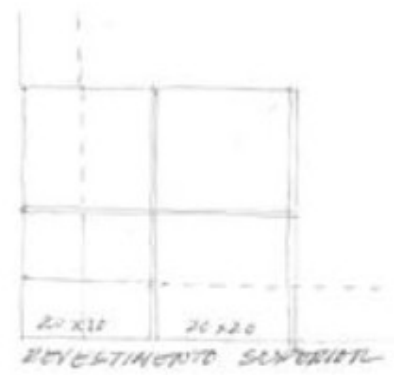
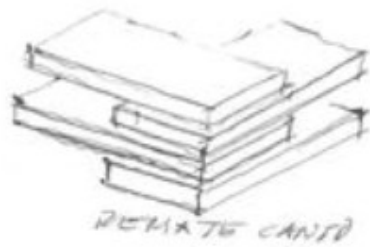
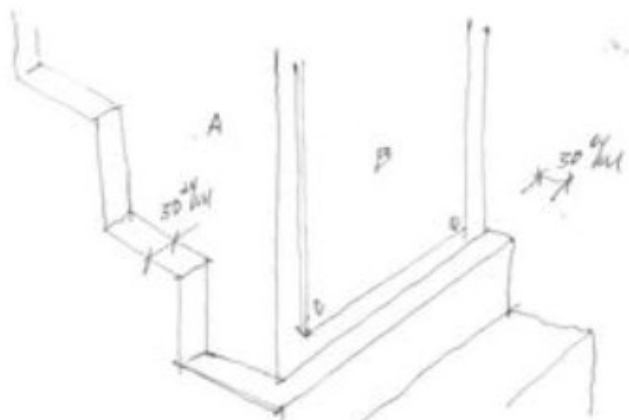

ALÇADO 1:50

A - MACIÇO ABSCURTADE
EM TIZOLO BURGO A VISTA

B - PLACA DE AÇO INOX COM
PLANTA DE MONSARAL COM
A INDICAÇÃO DOS EDIFÍCIOS
NOTÁVEIS OU VISITA-VEIS.

• PORTA DA VILA
• MONASTÉRIO

• VISTA GERAL

• PORTA DA VILA - MONASTÉRIO
• INDICAÇÃO DE ACESSO AO CAMINHO
DE FONDA

2012.01.31